

Service Manual

Amplifier

Amplifier

SE-CH770

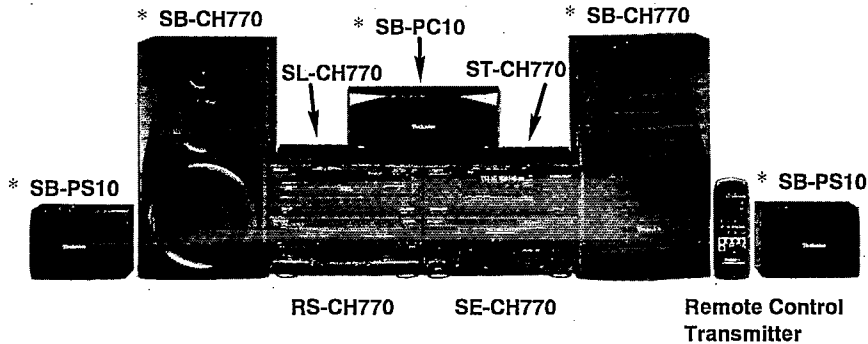
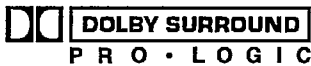

Colour

(K) : Black

Areas

Suffix for Model No.	Area	Colour
(E)	Europe	(K)
(EB)	Britain	
(EG)	Germany and Italy	
(GC)	Asia, Latin America, Middle East and Africa	
(GN)	Oceania	

Because of unique interconnecting cables, when a component requires service, send or bring in the entire system.

Specifications

Power output

DIN 1 kHz, THD 1%, both channel driven 2 × 50 W (6 Ω)

RMS 1 kHz, THD 10%, both channel driven 2 × 70 W (6 Ω)

[For (E), (EB), (EG) and (GN) areas] 2 × 70 W (6 Ω)

[For (GC) area] 2 × 65 W (6 Ω)

PRO LOGIC mode

DIN 1 kHz, THD 1 %

MAIN (both channels driven) 2 × 40 W (6 Ω)

SURROUND 40 W (4 Ω + 4 Ω)

CENTER 40 W (8 Ω)

RMS 1 kHz, THD 10 %

MAIN (both channels driven) 2 × 50 W (6 Ω)

SURROUND 50 W (4 Ω + 4 Ω)

CENTER 50 W (8 Ω)

[For (GC) area only]

PMPO 1kHz 1700 W

[MAIN (both channels driven) 6 Ω, SURROUND 4 Ω + 4 Ω,

CENTER 8 Ω]

Total harmonic distortion

Rated power at 1 kHz 1% (6 Ω)

Half power at 1 kHz 0.09% (6 Ω)

Load impedance

MAIN 6 Ω - 8 Ω

SURROUND

4 Ω - 8 Ω

CENTER

8 Ω

S/N (rated power)

MAIN 90 dB

General

Power consumption

[For (E), (EB), (EG) and (GN) areas] 210 W

[For (GC) area] 460 W

[THD 10 %, MAIN (both channels driven) 6 Ω, SURROUND 4 Ω + 4 Ω, CENTER 8 Ω]

Power supply

[For (E) and (EG) areas] 230 V, AC 50/60 Hz

[For (EB) and (GN) areas] 230 - 240 V, AC 50/60 Hz

[For (GC) area] 110/127/220/230-240 V, AC 50/60 Hz

Dimensions (W × H × D)

270 × 118.5 × 342.5 mm

Weight

4.9 kg

Notes:

Specifications are subject to change without notice.

Weight and dimensions are approximate.

Total harmonic distortion is measured by the digital spectrum analyzer.

System	Tuner/sound processor	Compact disc changer	Amplifier	Cassette deck	Front speakers	Center speaker	Surround speakers
SC-CH770	ST-CH770	SL-CH770	SE-CH770	RS-CH770	*SB-CH770	*SB-PC10	*SB-PS10

* For (E),(EB) and (EG) areas: Made in PAES
For (GC) and (GN) areas : Made in NABEL

WARNING

This service information is designed for experienced repair technicians only and is not designed for use by the general public. It does not contain warnings or cautions to advise non-technical individuals of potential dangers in attempting to service a product. Products powered by electricity should be serviced or repaired only by experienced professional technicians. Any attempt to service or repair the product or products dealt with in this service information by anyone else could result in serious injury or death.

Technics®

© 1996 Matsushita Electric Industrial Co., Ltd.
All rights reserved. Unauthorized copying and distribution is a violation of law.

Contents

	Page		Page
Before Repair	2	External Unit Connections	7
Protection Circuitry	2	Enjoy Sound with DOLBY PRO LOGIC	8, 9
Accessories	2	Operation Check and	
Caution of AC Mains Lead	3	Main Component Replacement Procedures	10 ~ 12
Location of Controls	3	Power Source ON/OFF of This Unit	12
Installation	4	Schematic Diagram	13 ~ 16
Flat Cable Connections	4	Printed Circuit Board Diagram	17 ~ 19
Antenna Connections	5	Wiring Connection Diagram	20
Connection of Front and Surround Speakers	5	Block Diagram	21
Connection of Center Speaker	6	Replacement Parts List	22 ~ 26
Connection of AC Power Supply Cord	6	Cabinet Parts Location	27
Optional Antenna Connections	6	Packaging	28

Before Repair

- (1) Turn off the power supply. Using a 10 Ω, 10 W resistor, connect both ends of power supply capacitors (C701, C702) in order to discharge the voltage.
- (2) Before turning the power supply on, after completion of repair, slowly apply the primary voltage by using a power supply voltage controller to make sure that the consumed current at 50/60 Hz in NO SIGNAL mode should be shown below with respect to supply voltage 230 V/240 V.

Area	(E) (EG)	(EB)	(GC)	
Power supply voltage	AC 230 V	AC 240 V	AC 110 V	AC 240 V
Consumed current 50 Hz	60 ~ 240 mA	60 ~ 240 mA	120 ~ 480 mA	60 ~ 240 mA

Protection Circuitry

The protection circuitry may have operated if either of the following conditions is noticed:

- * No sound is heard when the power is switched ON.
- * Sound stops during a performance.

The functions of this circuitry is to prevent circuitry damage if, for example, the positive and negative speaker connection wires are "shorted", or if speaker systems with an impedance less than the indicated rated impedance of this unit are used.

If this occurs, follow the procedure outlined below:

1. Switch OFF the power.
2. Determine the cause of the problem and correct it.
3. Switch ON the power once again.

Note:

When the protection circuitry functions, the unit will not operate unless the power is first switched OFF and then ON again.

Accessories

- AC power supply cord
(E), (EG) and (GC) areas : (RJA0019-2K) 1
(EB) area : (VJA0733) 1
- Flat cable
Long (REX0661) 1
Medium (REX0660) 1
Short (REX0608) 1
- Remote control transmitter
(RAK-CH202WH) 1
- Batteries
(UM-4, "AAA", R03) 2
- AM (LW/MW) loop antenna
(RSA0012) 1
- Antenna holder
(RMN0244) 1
- Mounting screw
(XTN3+12AFZ) 1
- FM indoor antenna
(E), (EB) and (EG) areas : (RSA0007) 1
(GC) area : (RSA0006) 1
- Speaker cords
(REE0393) 2
- Attachment plug
for (EB) area only (SJP9009) 1
- Power plug adaptor
for (GC) area only (SJP5213-2) 1

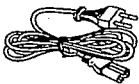

(E), (EG) and (GC)



(EB)

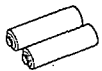
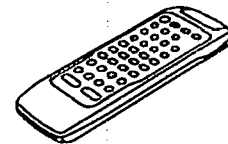

(E), (EB) and (EG)



(GC)

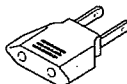

■ Caution for AC Main Lead



[(EB) area code model only]

For your safety, please read the following text carefully.

This appliance is supplied with a moulded three pin mains plug for your safety and convenience.

A 5-ampere fuse is fitted in this plug.

Should the fuse need to be replaced please ensure that the replacement fuse has a rating of 5-ampere and that it is approved by ASTA or BSI to BS1362.

Check for the ASTA mark  or the BSI mark  on the body of the fuse.

If the plug contains a removable fuse cover you must ensure that it is refitted when the fuse is replaced.

If you lose the fuse cover the plug must not be used until a replacement cover is obtained.

A replacement fuse cover can be purchased from your local dealer.

CAUTION!

IF THE FITTED MOULDED PLUG IS UNSUITABLE FOR THE SOCKET OUTLET IN YOUR HOME THEN THE FUSE SHOULD BE REMOVED AND THE PLUG CUT OFF AND DISPOSED OF SAFELY.

THERE IS A DANGER OF SEVERE ELECTRICAL SHOCK IF THE CUT OFF PLUG IS INSERTED INTO ANY 13-AMPERE SOCKET.

If a new plug is to be fitted please observe the wiring code as shown below.

If in any doubt please consult a qualified electrician.

IMPORTANT

The wires in this mains lead are coloured in accordance with the following code:

Blue: Neutral

Brown: Live



As the colours of the wires in the mains lead of this appliance may not correspond with the coloured markings identifying the terminals in your plug, proceed as follows:

The wire which is coloured BLUE must be connected to the terminal in the plug which is marked with the letter N or coloured BLACK.

This apparatus was produced to BS 800.

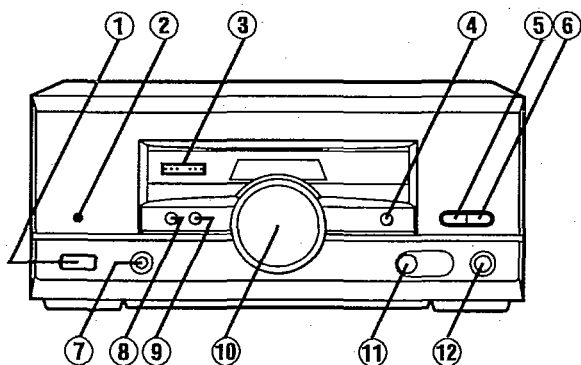
■ Location of Controls



- ① Power "STANDBY /ON" switch (POWER, "STANDBY" /ON)
- ② Standby indicator (STANDBY)
- ③ Dolby Pro Logic indicators (SURROUND, 3 STEREO)
- ④ Center mode select button (CENTER MODE)
- ⑤ EQ SPACE/flat button (EQ SPACE/FLAT)
- ⑥ V.bass button (V.BASS)
- ⑦ Headphones jack (PHONES) (Ø 3.5, 32 Ω)
- ⑧ DOLBY PRO LOGIC mode select button ( PRO LOGIC)
- ⑨ Test signal button (TEST)
- ⑩ Volume control (VOLUME)
- ⑪ Microphone jack (MIC) (Ø 6.3, 600 Ω)
- ⑫ Microphone volume control (MIC VOL)

The wire which is coloured BROWN must be connected to the terminal in the plug which is marked with the letter L or coloured RED.

Under no circumstances should either of these wires be connected to the earth terminal of the three pin plug, marked with the letter E or the Earth Symbol .

Before use

Removal the connector cover as follows.

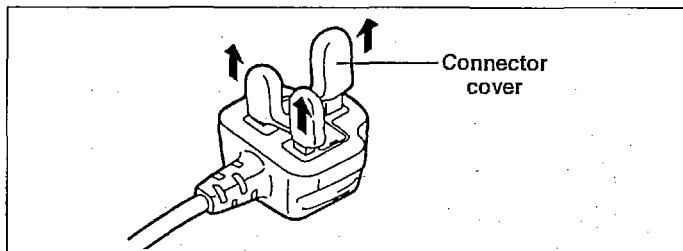

How to replace the fuse

1. Remove the fuse cover with a screwdriver.

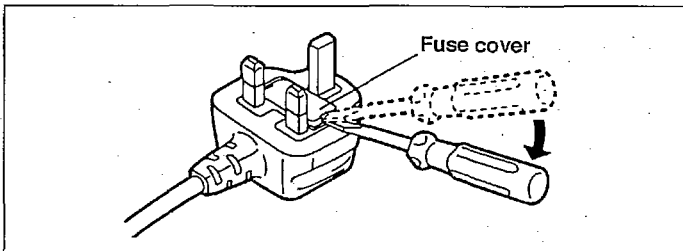

2. Replace the fuse and attach the fuse cover.

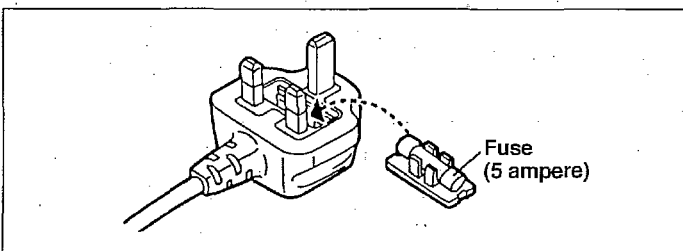

Installation

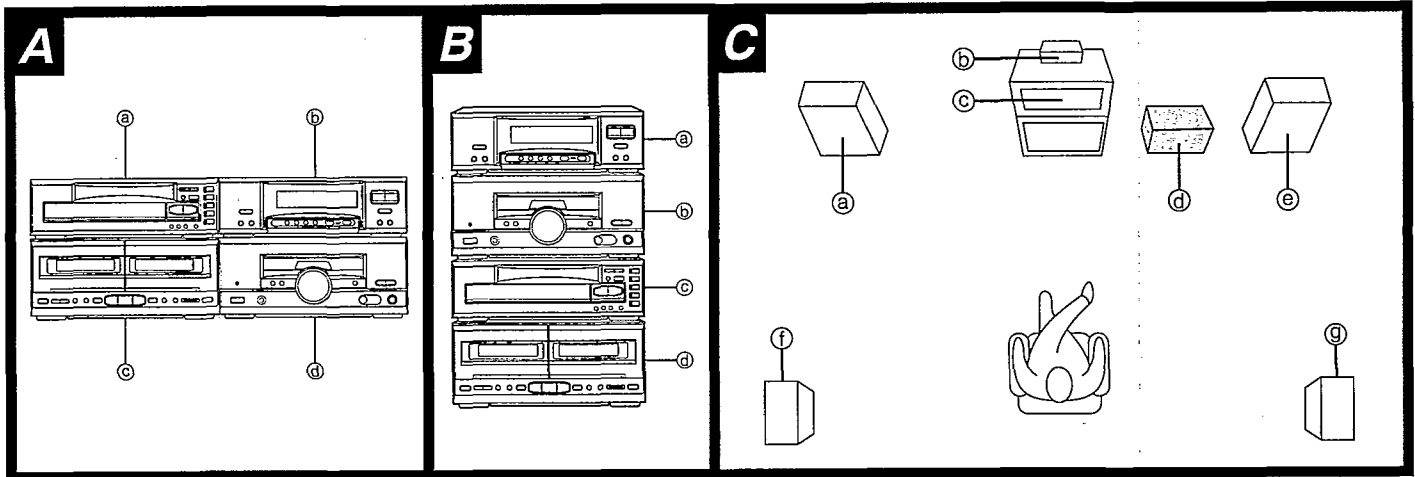

Stacking the components

Horizontal stacking **A**

- a CD changer (SL-CH770)
- b Tuner/sound processor (ST-CH770)
- c Cassette deck (RS-CH770)
- d Amplifier (SE-CH770)

Vertical stacking **B**

- a Tuner/sound processor (ST-CH770)
- b Amplifier (SE-CH770)
- c CD changer (SL-CH770)
- d Cassette deck (RS-CH770)

Placement of speakers **C**

As well as enjoying normal stereo reproduction with the left and right front speakers, a center speaker and surround speakers can also be connected to the unit in order to enjoy the sound performance of DOLBY PRO LOGIC Systems.

We recommend that surround speakers be placed on the side of or slightly behind the listener, and about one meter higher than ear level.

However the position should be adjusted to your personal preference, because the effect varies to some degree depending upon the type of music and the music source.

- a Front speaker (Left) (SB-CH770)
- b Center speaker (SB-PC10)
- c TV (not included)
- d This system
- e Front speaker (Right) (SB-CH770)
- f Surround speaker (Left) (SB-PS10)
- g Surround speaker (Right) (SB-PS10)

Flat Cable (included) Connections

Before marking connections:

Make sure the white line on the cable is on the right side.

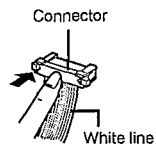

To unplug cables:

Hold the connector from both ends.



Note Do not try connecting or disconnecting the flat cables while the power is switched to ON.

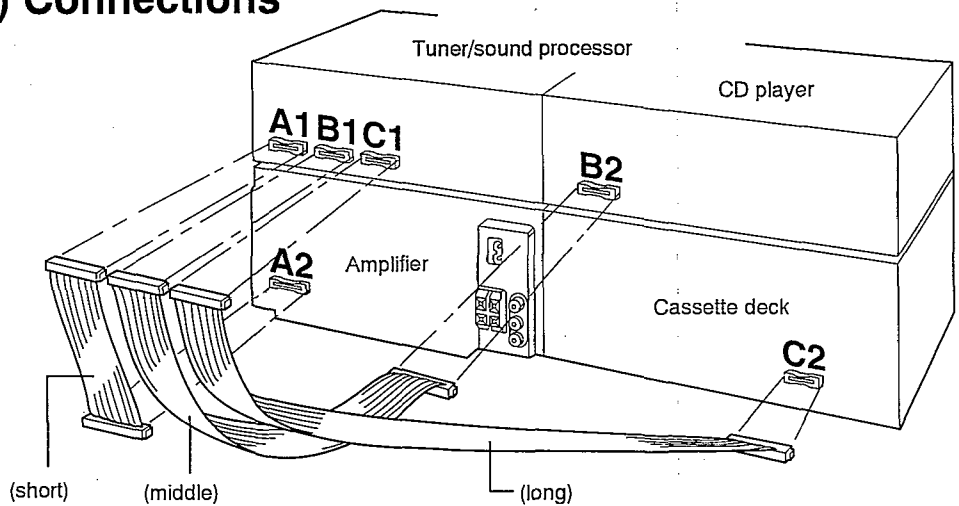

After connection:

Fold and press the cable as flat to the back of the unit as possible. (To minimize noise pickup while listening an MW/LW broadcast)

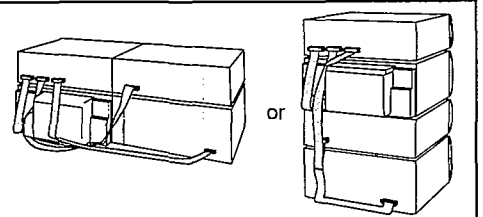

■ Antenna Connections

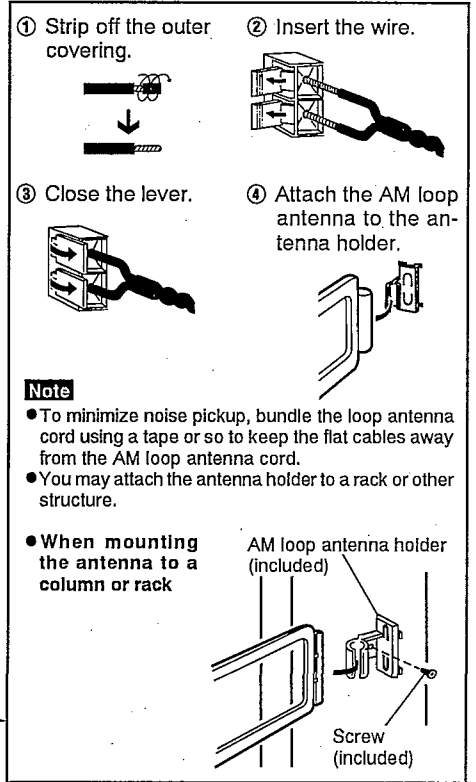
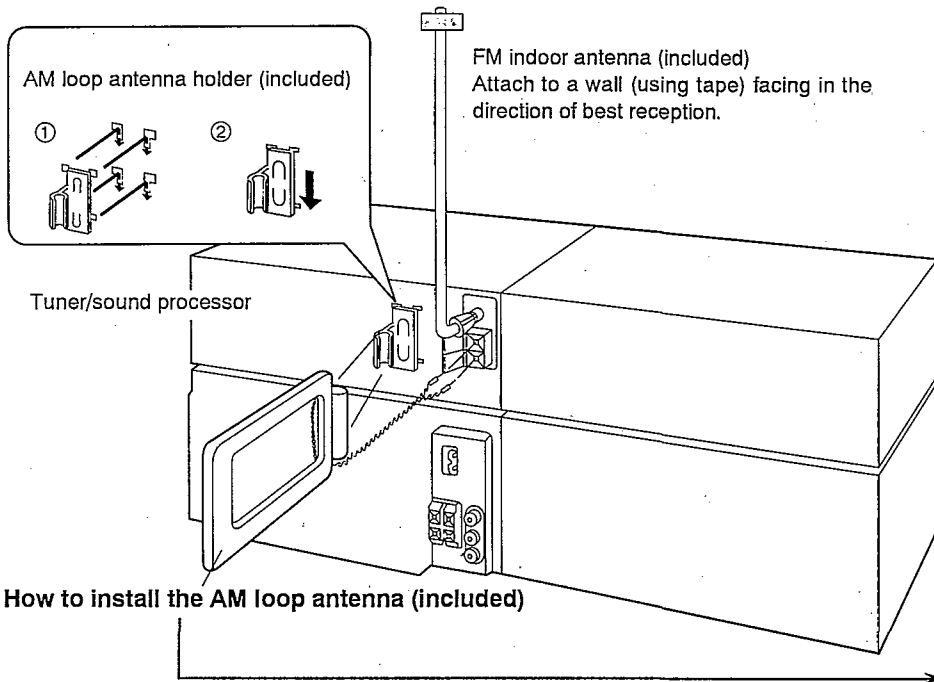

■ Connection of Front and Surround Speakers

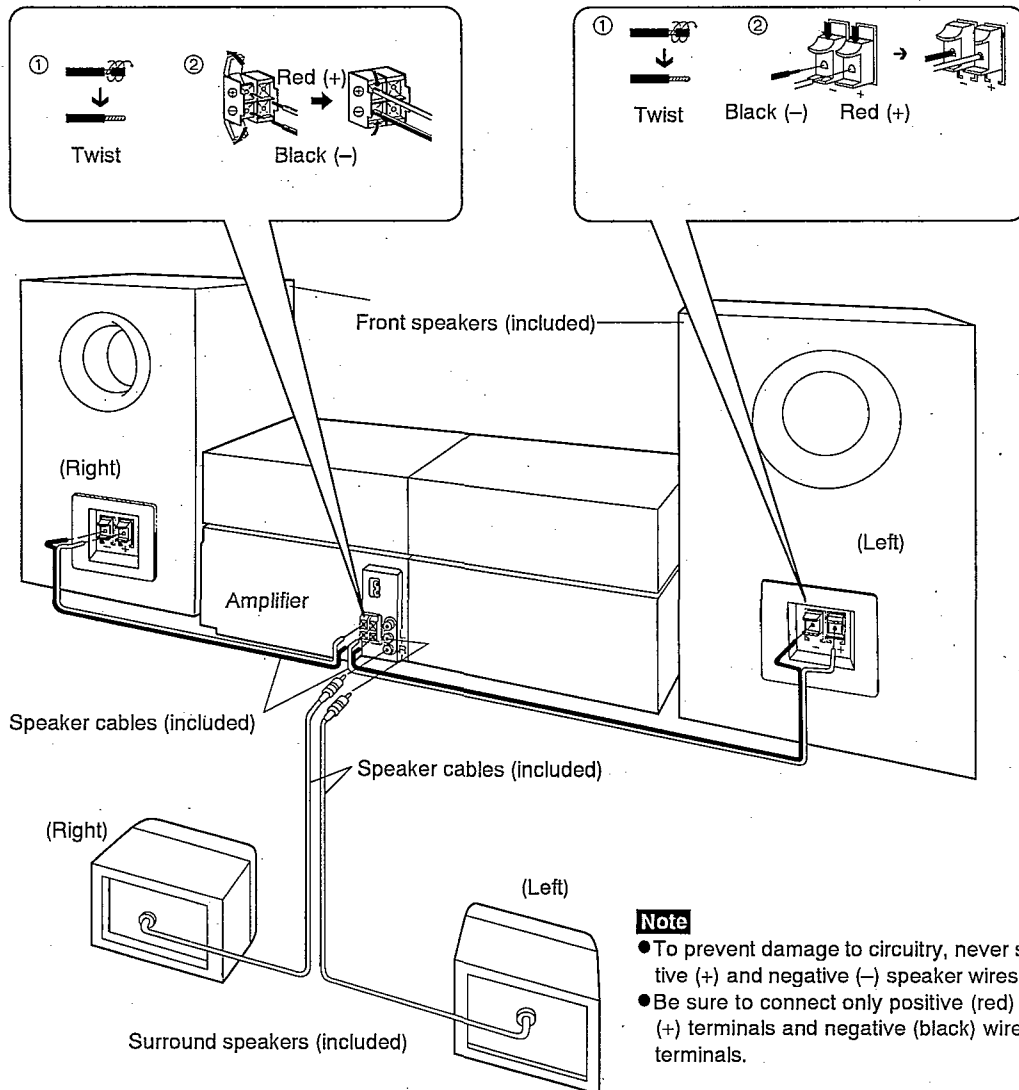

■ Connection of Center Speaker

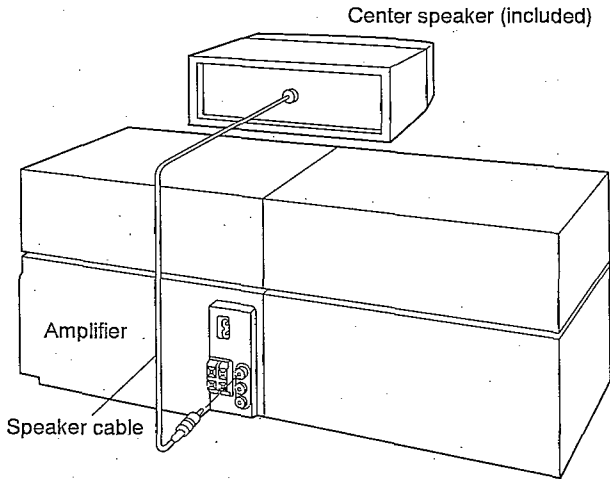

■ Connection of AC Power Supply Cord

● Plug the cord into an outlet only after all other connections have been made.

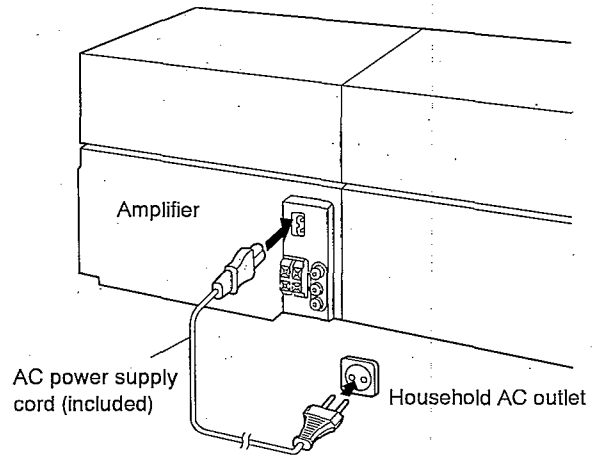

Insertion of Connector:

Even when the connector is perfectly inserted, depending on the type of inlet used, the front part of the connector may jut out as shown in the drawing.

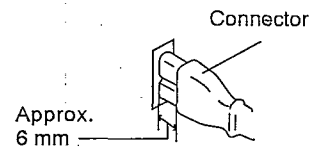

■ Optional Antenna Connections

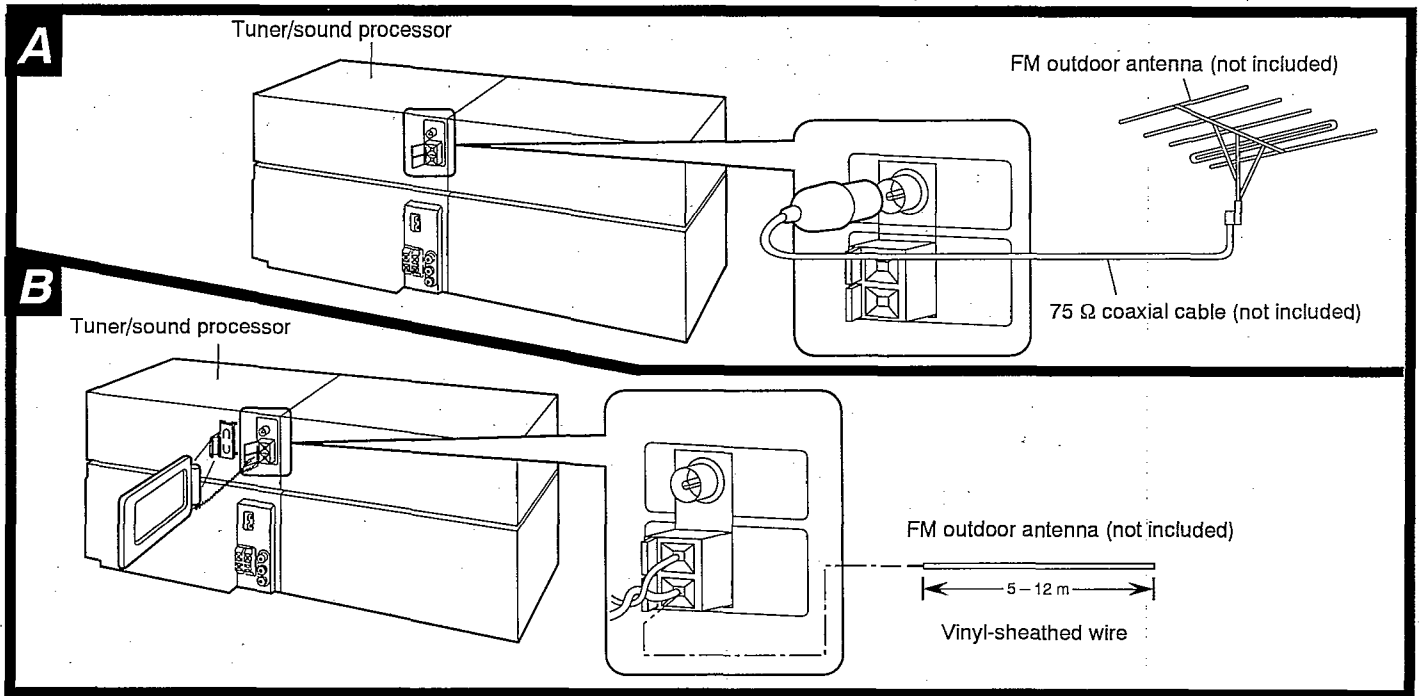

FM outdoor antenna (not included)

The outdoor antenna should be used when using this unit in mountainous areas or in spaces enclosed by reinforced concrete where the FM indoor antenna (included) does not provide satisfactory reception.

Note

An outdoor antenna should be installed by a qualified technician only.

AM (MW/LW) outdoor antenna (not included)

The outdoor antenna should be used when using this unit in mountainous areas or in spaces enclosed by reinforced concrete where the AM loop antenna (included) does not provide satisfactory reception.

Use 5-12 m of vinyl-sheathed wire horizontally at the window, or a convenient location.

When the unit is not in use, disconnect the outdoor antenna to prevent possible damage from lightning. Never use an outdoor antenna during an electrical storm.

Note

Be sure to connect the AM loop antenna even when an outdoor antenna is used.

External Unit Connections

- Make sure that the power supply for all components has been turned off before making any connections.
- For details, refer to the operating instructions of the units which are to be connected.
- All peripheral components and cables sold separately.

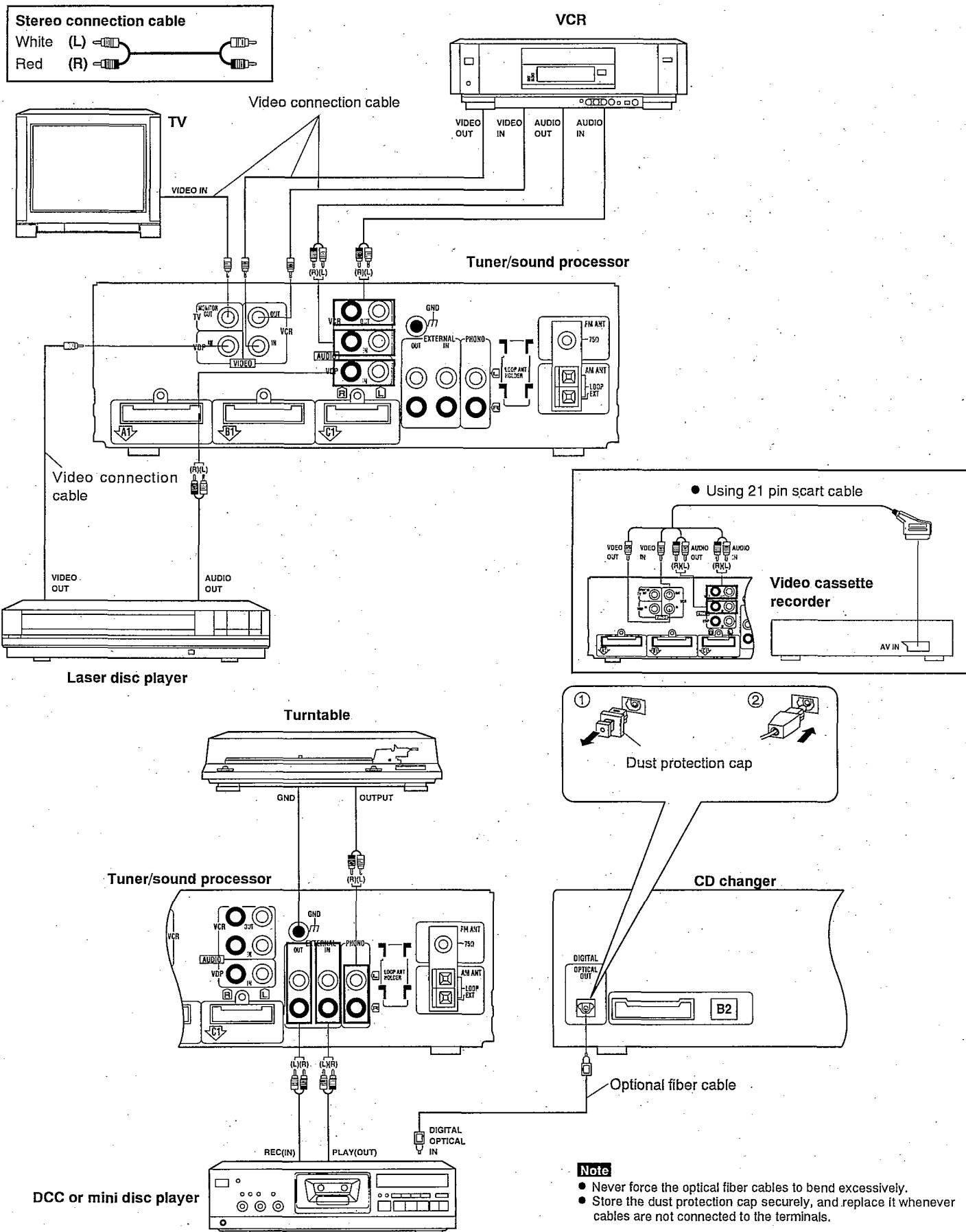

■ Enjoying Sound with DOLBY PRO LOGIC

By combining front, center and surround speakers, you can enjoy the SURROUND mode which conveys a feeling of presence or the 3 STEREO mode which conveys a feeling of orientation.

SURROUND

By reproducing the feeling of depth and movement of sound, video software or compact discs recorded with Dolby Surround provide the listener with a feeling of presence like that of a movie theater.

To enjoy SURROUND, be sure to connect the surround speakers.

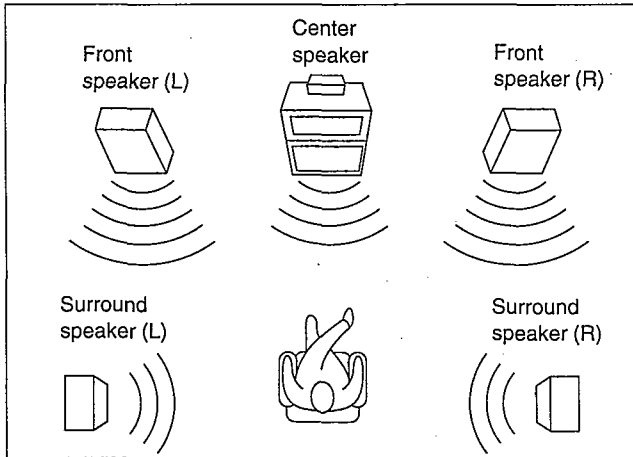

3 STEREO

You can enjoy audio/video sources with clear sound, more presence and a good feeling of orientation. 3 STEREO can be used with sources not recorded in DOLBY SURROUND.

To enjoy 3 STEREO, be sure to connect the center speaker.

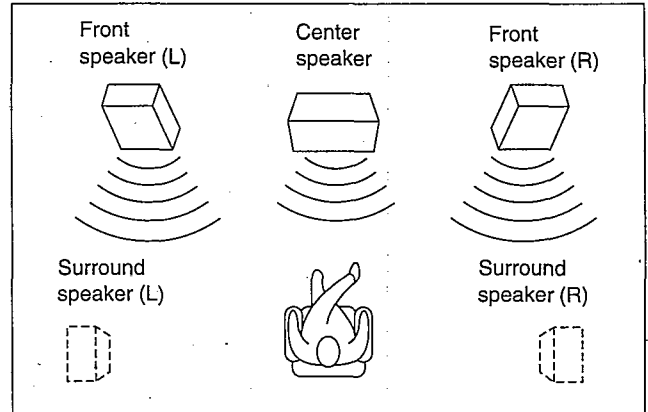

Manufactured under license from Dolby Laboratories Licensing Corporation.
DOLBY, and the double-D symbol  and "PRO LOGIC" are trademarks of Dolby Laboratories Licensing Corporation.

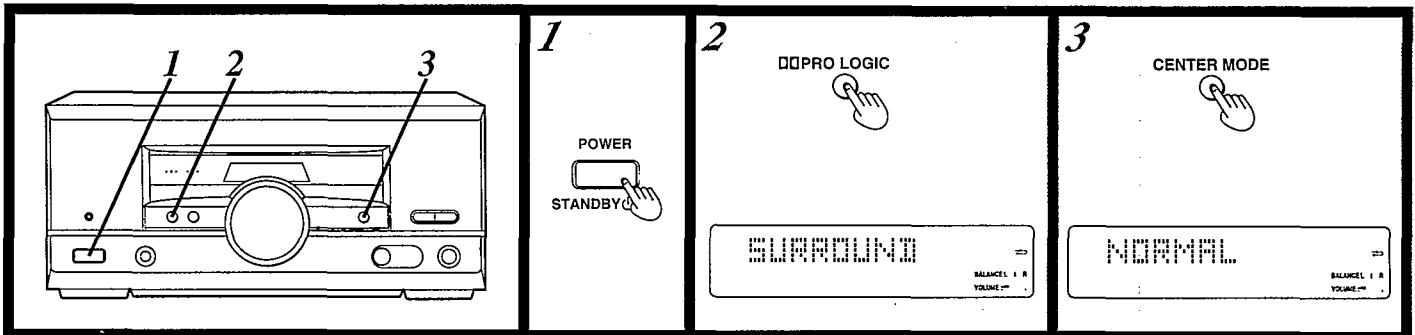

Setting the center mode

For Dolby Pro Logic systems, center mode setting is necessary to play back bass sounds effectively. Set the center mode in accordance with the size of your center speaker.

- 1** Switch on the power.
- 2** Press PRO LOGIC to select "SURROUND" or "3 STEREO".
Each time you press the button, the display will change as follows:
SURROUND → 3 STEREO → OFF

- 3** Press CENTER MODE to select "NORMAL" mode. Each time you press the button, the display will change as follows:
NORMAL → WIDE → PHANTOM

Note

"PHANTOM" will not be displayed when you select "3 STEREO" in step 2.

NORMAL:

When the center speaker is smaller than the front speakers

WIDE:

When the center speaker is the same or larger size as the front speakers

PHANTOM: SURROUND only

When no center speaker is connected.

Note

In the PHANTOM mode, the sound which would have been sent to the center speaker will be divided equally between both the left and right front speakers.

■ Operation Check and Main Component Replacement Procedures

NOTE

1. This section describes procedures for checking the operation of the major printed circuit boards and replacing the main components.
2. For reassembly after operation checks or replacement, reverse the respective procedures. Special reassembly procedures are described only when required.
3. Select items from the following index when checks or replacement are required.
4. Illustrated screws are equivalent to actual size.
5. Refer the parts No. on the page of "Main Component Replacement Procedures", if necessary.

● Contents

•Checking Procedures for each P.C.B.

	Page.
1. Checking for the operation P.C.B.	10.
2. Checking for the main P.C.B.	11.

•Main Component Replacement Procedures



1. Replacement for the power IC and regulator transistor.	12.
--	-----

■ Checking Procedure for each P.C.B.

1. Checking for the operation P.C.B.

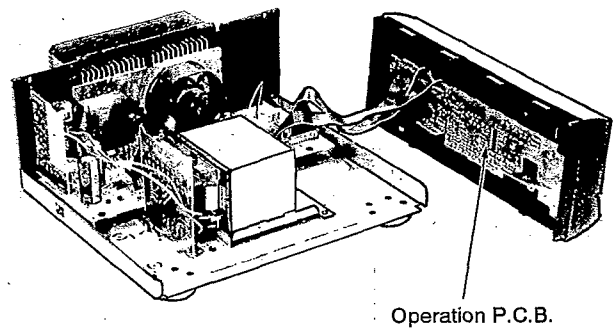
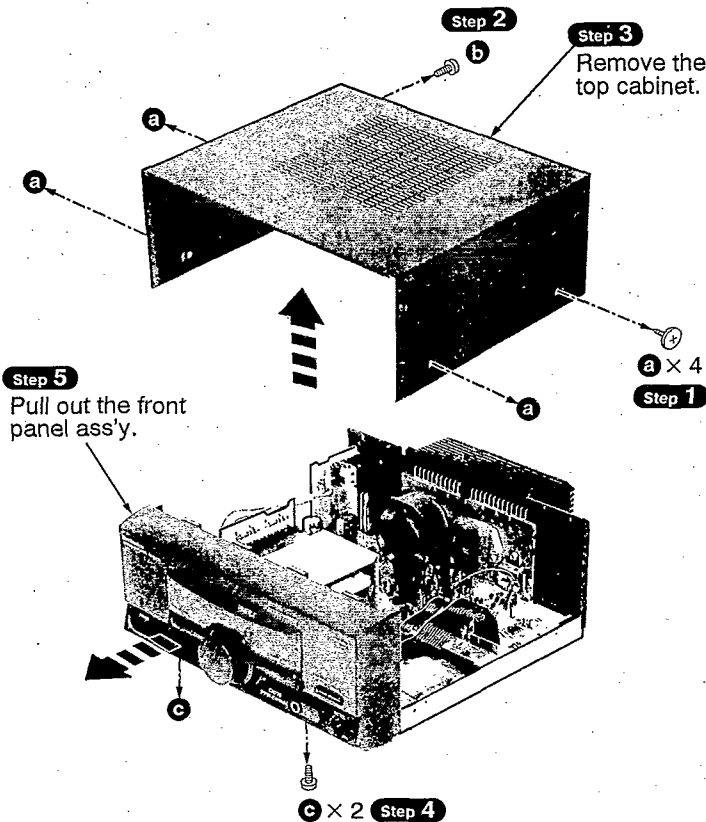
• Check the operation P.C.B. as shown below.



-  **a**
[RHD30007-K1] (Black)
-  **b**
[XTBS3+10JFZ1] (Black)
-  **c**
[XTBS3+8JFZ1] (Black)

2. Checking for the main P.C.B.

Step 3
Remove the cabinet.

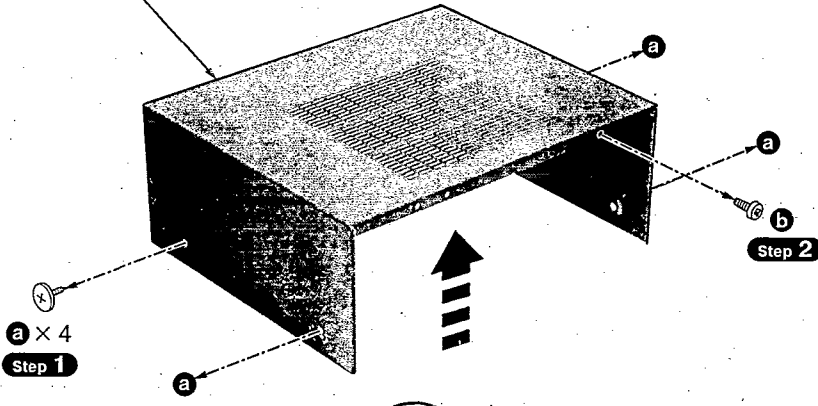

Step 1
a × 4

Step 2

- a**
[RHD30007-K1] (Black)
- b**
[XTBS3+10JFZ1] (Black)
- c**
[XTB3+10JFZ] (Black)
- d**
[XTB3+20JFZ] (Black)

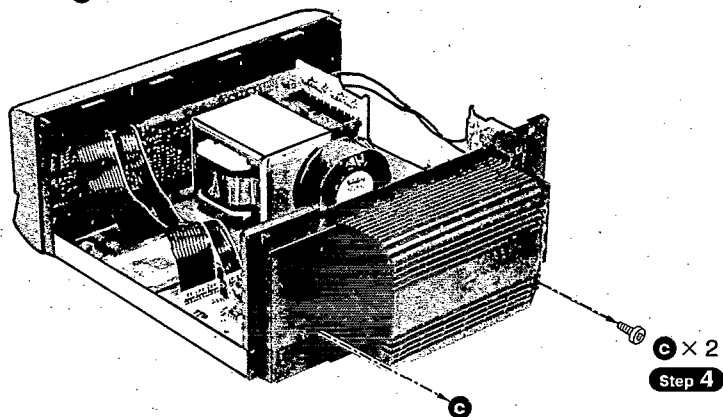

Step 4
c × 2

• Check the main P.C.B. as shown below.

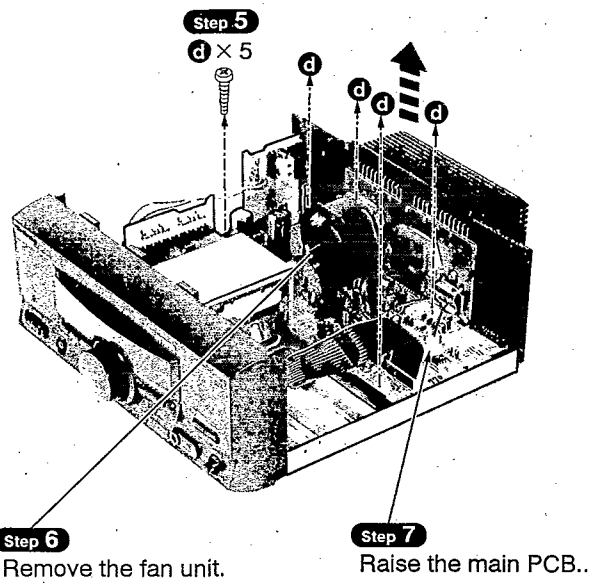

Step 6
Remove the fan unit.

Step 7
Raise the main PCB..

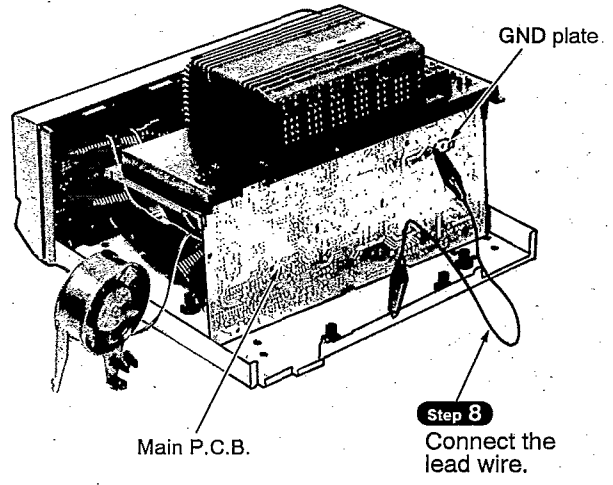

Main P.C.B.

GND plate.

Step 8
Connect the lead wire.

Main Component Replacement Procedures

1. Replacement for the power IC and regulator transistor

- Follow the item 2 (**Step 1** ~ **Step 7**) checking procedures for each P.C.B. on page 11.

NOTE

When mounting the power IC or regulator transistor, apply silicone compound (RFKX0002) to the rear side of power IC or regulator transistors.

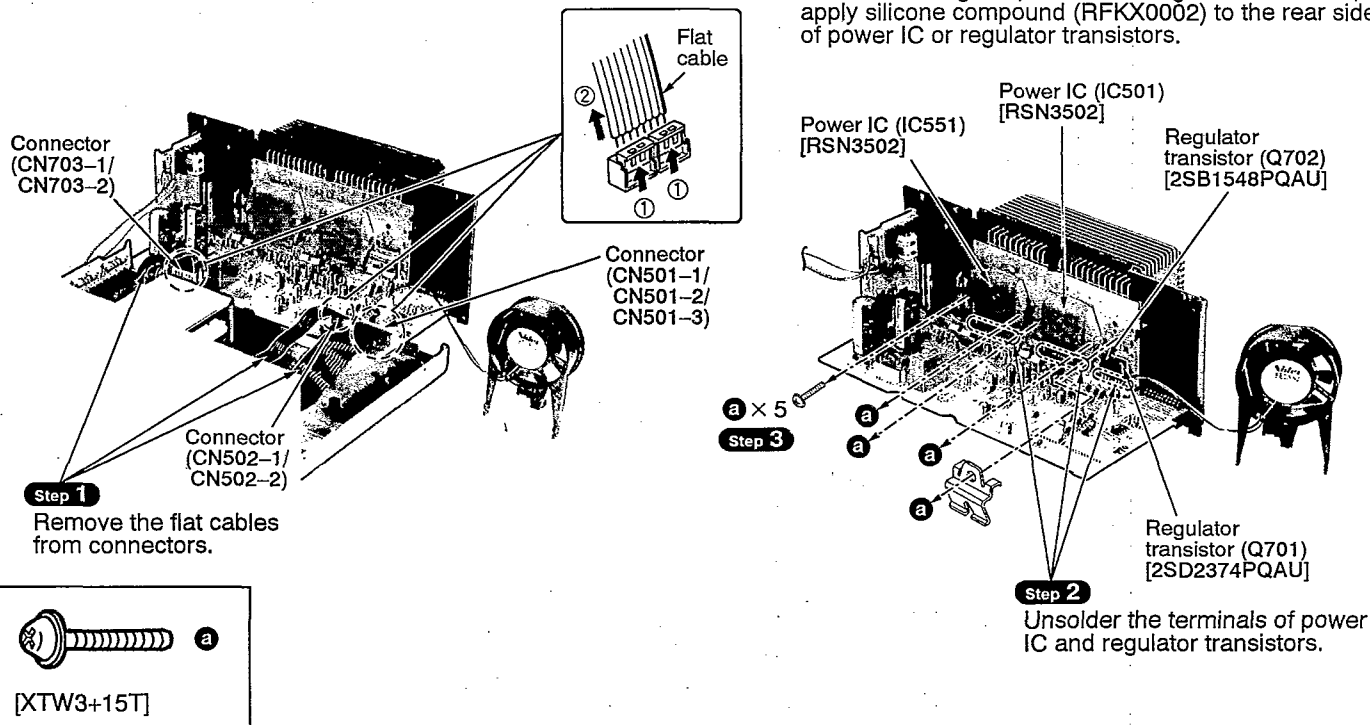

Power Source ON/OFF of This Unit

- Connect this unit to an AC outlet by the AC power cord. (This unit comes to stand-by mode.)
- Short the test point **TP701** in Fig. 1. This unit comes to power ON mode.

Operation Check

- Set this unit to power ON mode.
- Input a signal (1 kHz, 100mV), and confirm it to be outputted from the speaker terminal.

	INPUT	OUTPUT
Lch	J603 - J308	Lch speaker terminal
Rch	J604 - J308	Rch speaker terminal
Surround	J611 - J308	Surround speaker terminal (To output a signal, both Lch and Rch should be connected.)
Center	J612 - J308	Center speaker terminal

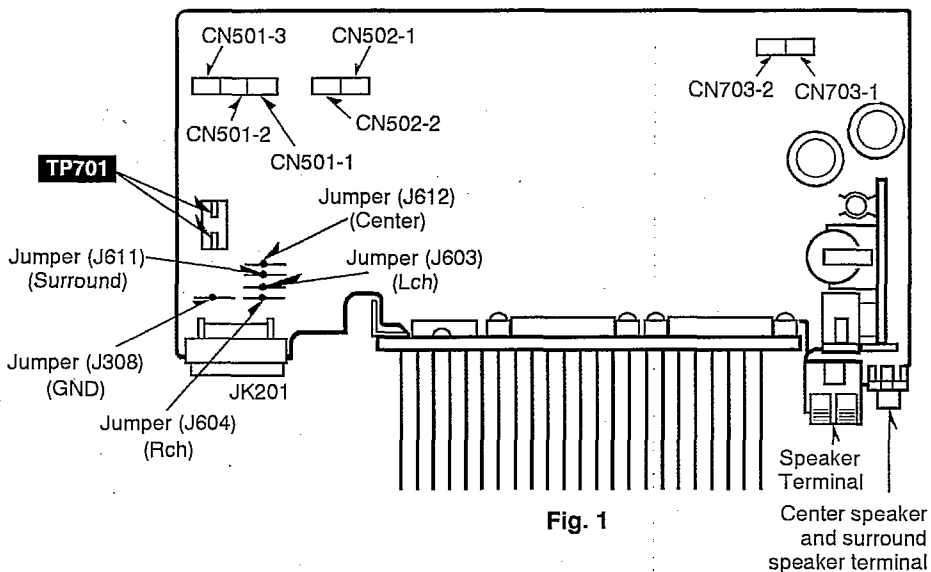

Fig. 1

Schematic Diagram

Page

A	OPERATION CIRCUIT	14
B	MAIN CIRCUIT	15, 16
C	POWER TRANSFORMER CIRCUIT [For (E), (EB), (EG) and (GN) areas]	16
	[For (GC) area]	13
D	AC IN TERMINAL CIRCUIT [For (E), (EB) and (EG) areas]	16
D	VOLTAGE SELECTOR CIRCUIT [For (GC) area]	13
E	AC INPUT TERMINAL CIRCUIT [For (GC) area]	13

• This schematic diagram may be modified at any time with the development of new technology.

Notes:

- **S601** : Power "STANDBY ϕ /ON" switch (POWER STANDBY ϕ /ON)
- **S602** : Pro logic on/off switch (PRO LOGIC)
- **S603** : Test signal on/off switch (TEST)
- **S605** : Center mode select switch (CENTER MODE)
- **S607** : EQ SPACE/FLAT switch (EQ SPACE/FLAT)
- **S608** : V. BASS switch (V. BASS)
- **S701** : Voltage select switch ...for (GC) area only
- **VR401** : Microphone volume control (MIC VOL)
- **VR601** : Volume control (VOLUME)

• Indicated voltage values are the standard values for the unit measured by the DC electronic circuit tester (high-impedance) with the chassis taken as standard. Therefore, there may exist some errors in the voltage values, depending on the internal impedance of the DC circuit tester.
No mark: Power ON

• Important safety notice:

Components identified by Δ mark have special characteristics important for safety. Furthermore, special parts which have purposes of fire-retardant (resistors), high-quality sound (capacitors), low-noise (resistors), etc. are used. When replacing any of components, be sure to use only manufacturer's specified parts shown in the parts list.

• **Caution!**

IC and LSI are sensitive to static electricity.
Secondary trouble can be prevented by taking care during repair.
Cover the parts boxes made of plastics with aluminum foil.
Ground the soldering iron.
Put a conductive mat on the work table.
Do not touch the legs of IC or LSI with the fingers directly.

• **Voltage and signal line**

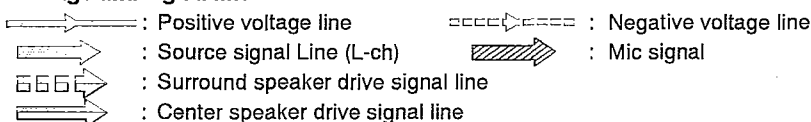

Power Source For[GC]area. (P.C.Board: on page 19)

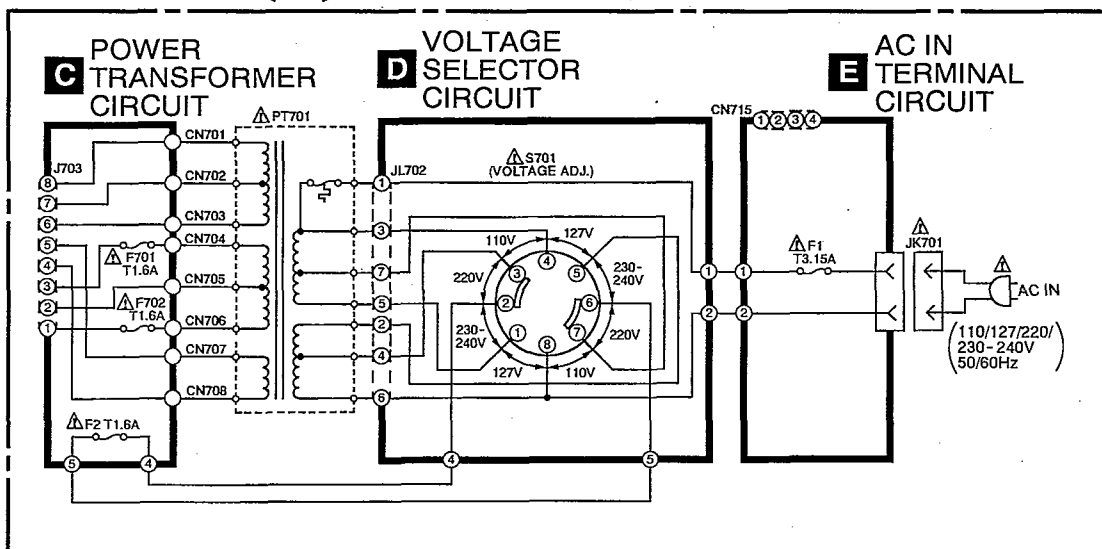

A OPERATION CIRCUIT (P.C.Board: on page 18)

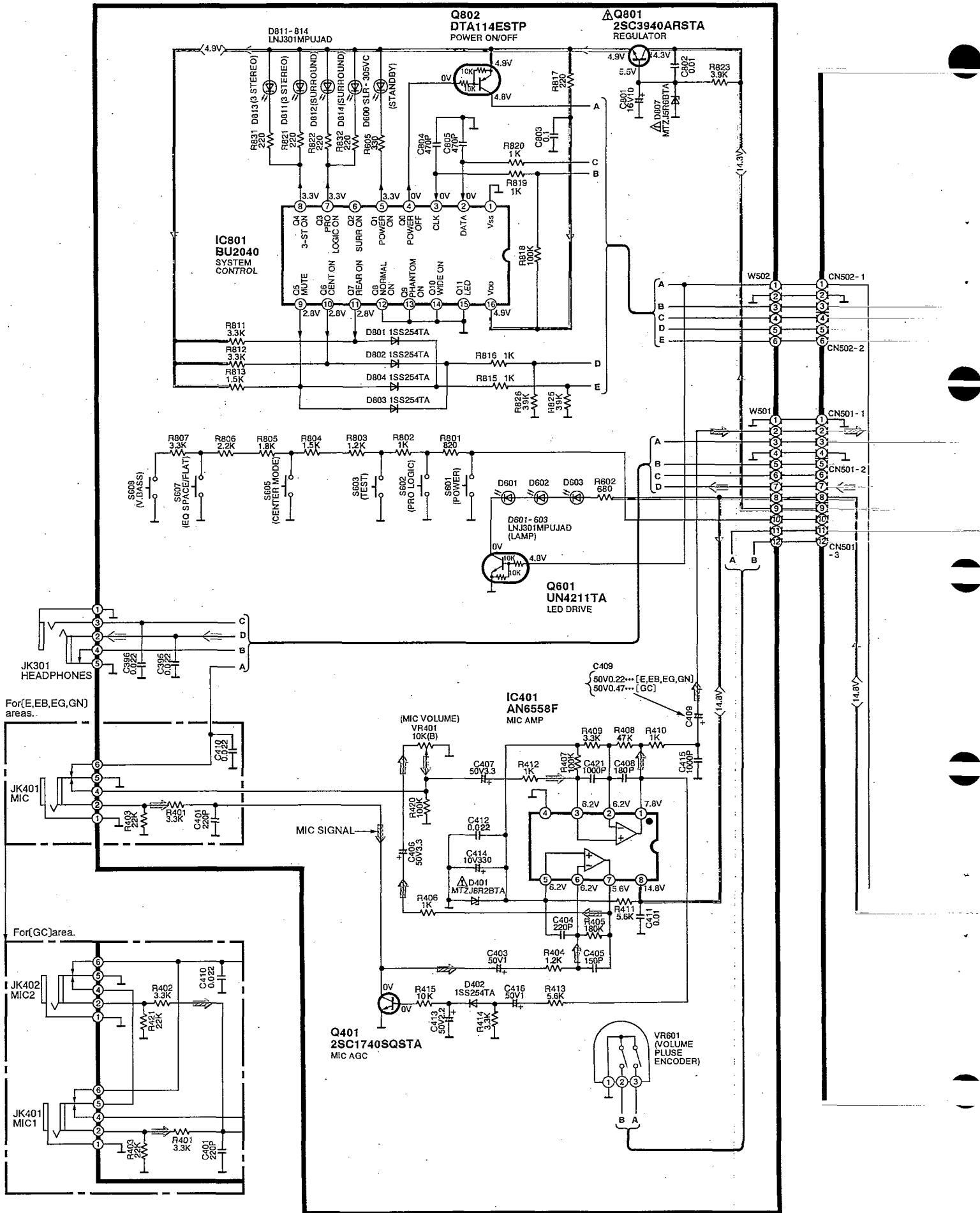



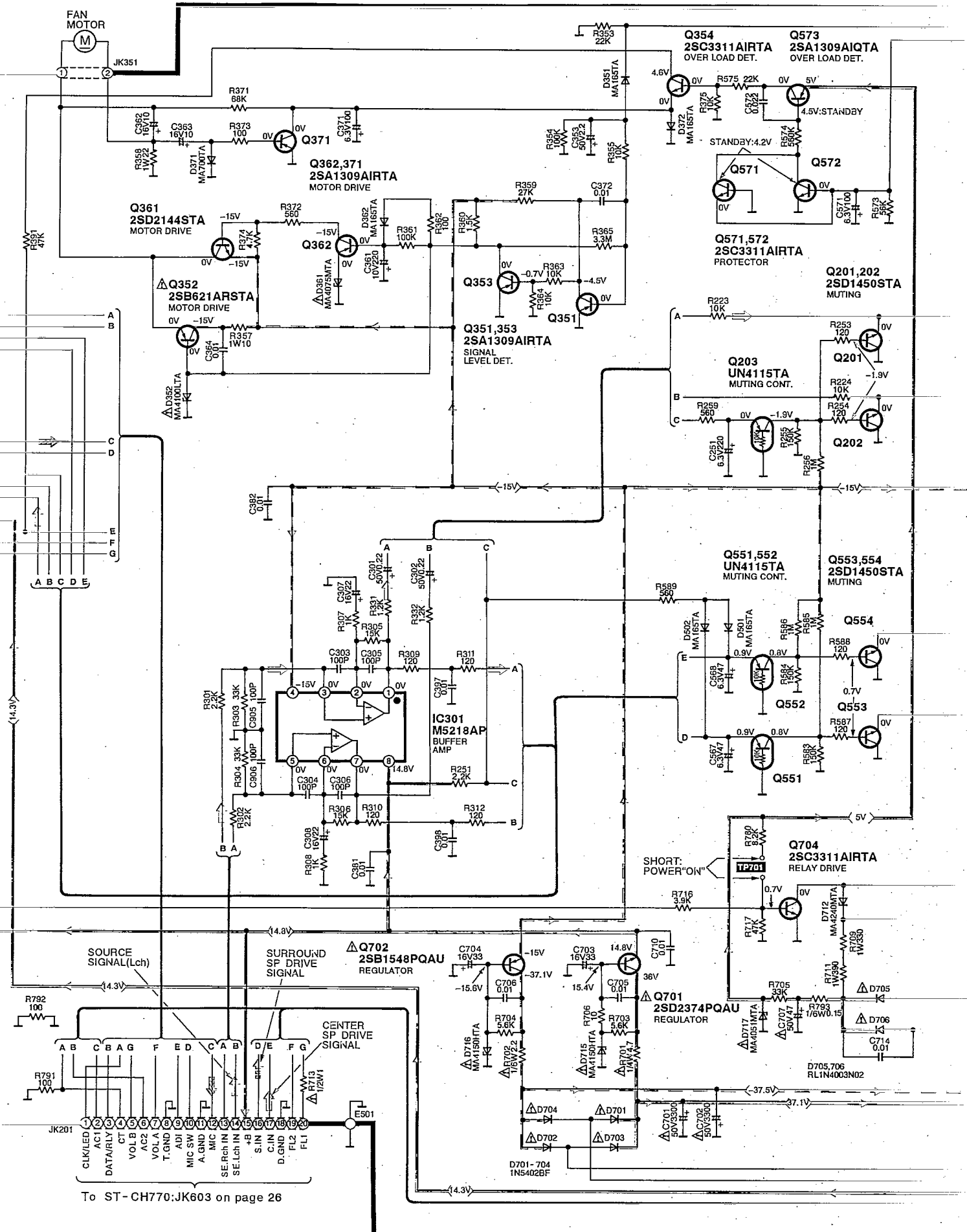

Surround speaker drive signal line, Center speaker drive signal line, Source signal Line (L-ch), Mic signal line, Positive voltage line, Negative voltage line

B MAIN CIRCUIT (P.C.Board: on page 17)



To ST-CH770:JK603 on page 26

 : Surround speaker drive signal line
  : Center speaker drive signal line
 : Source signal Line (L-ch)
  : Positive voltage line
  : Negative voltage line

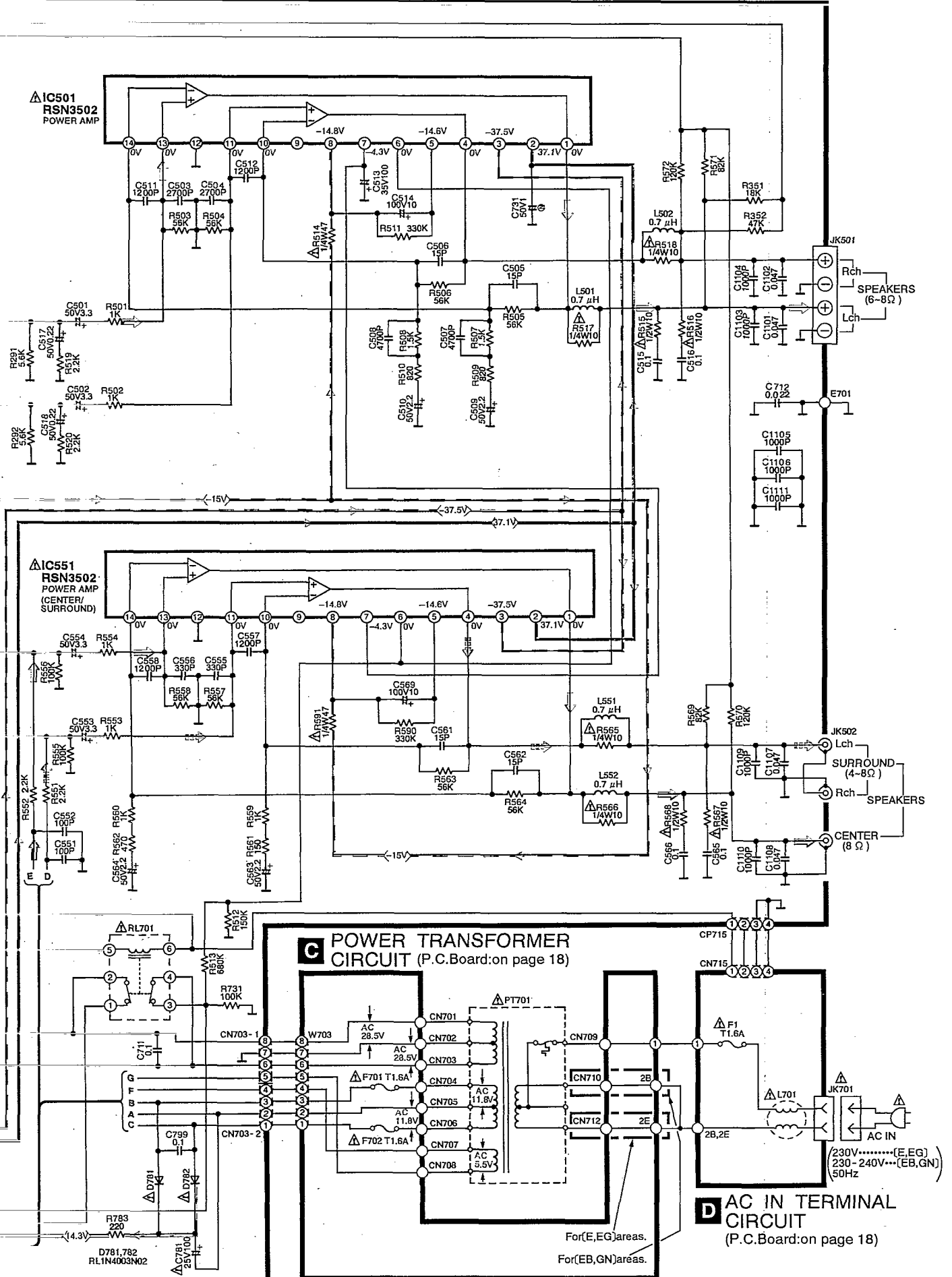

Printed Circuit Board Diagram

• This circuit board diagram may be modified at any time with the development of new technology.

B MAIN P.C.B. (REP2363B-M)

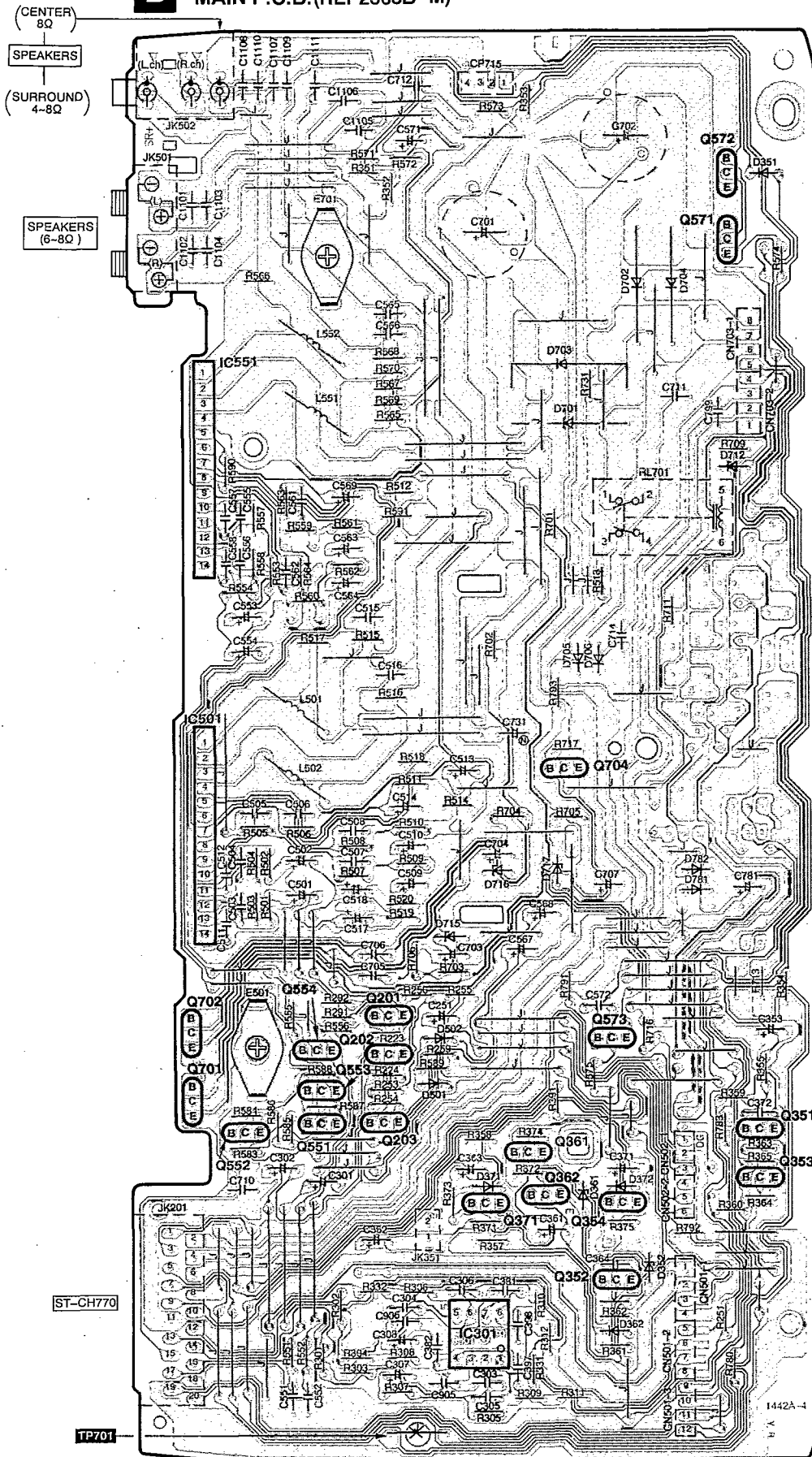

A OPERATION P.C.B.
 (REP2361A-S...[E,EB,EG,GN])
 (REP2361B-S...[GC])

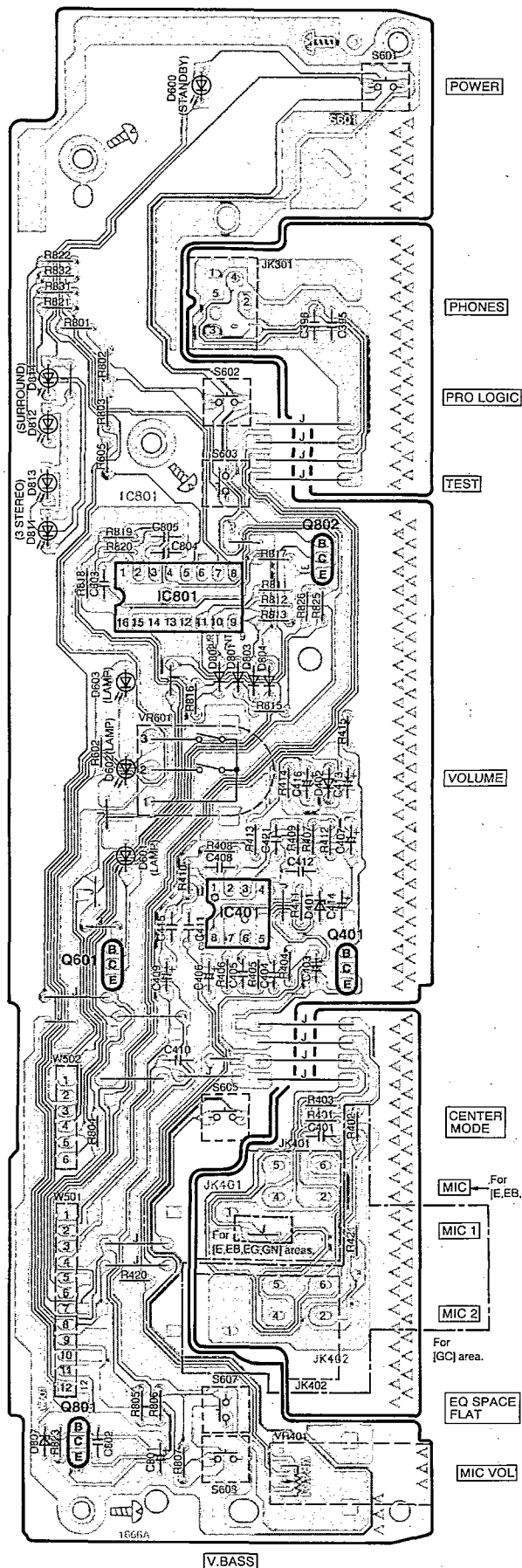

C POWER TRANSFORMER P.C.B.
 (REP2109D-P...[E,EG])
 (REP2109E-P...[EB])
 (REP2109F-P...[GN])

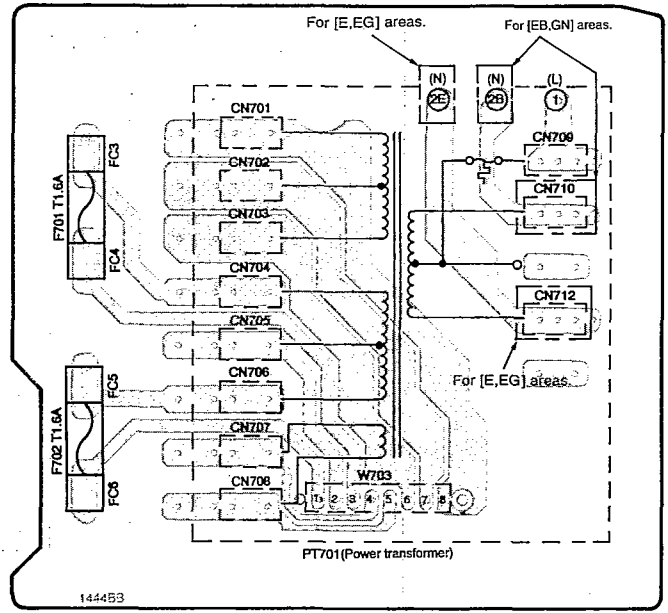

D AC IN TERMINAL P.C.B. (REP2109D-P...[E,EG])
 (REP2109E-P...[EB])
 (REP2109F-P...[GN])

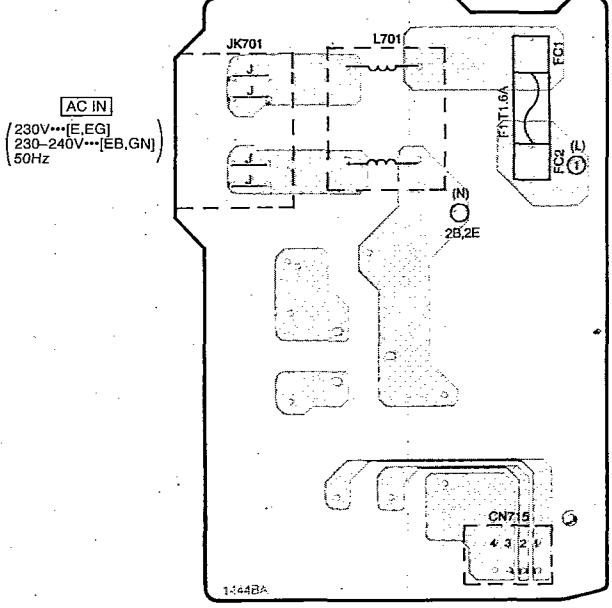

- POWER
- PHONES
- PRO LOGIC
- TEST
- VOLUME
- CENTER MODE
- MIC For [E,EB,EG,GN] areas.
- MIC 1
- MIC 2
- For [GC] area.
- EQ SPACE FLAT
- MIC VOL

Power Source P.C.B. For [GC] area.

C POWER TRANSFORMER P.C.B. (REP2152B-P)

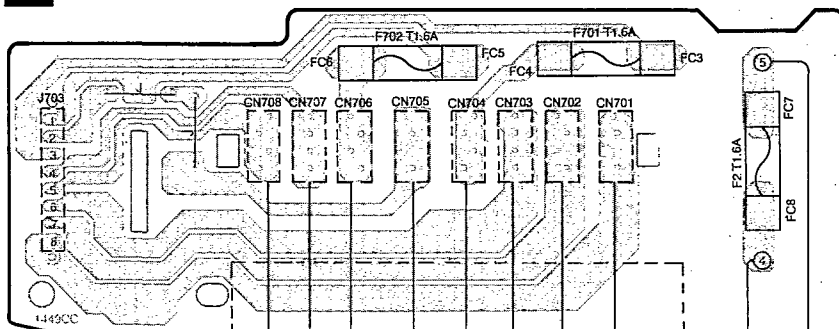

E AC IN TERMINAL P.C.B. (REP2152B-P)

AC IN
(110/127/220/230-240V)
50/60Hz

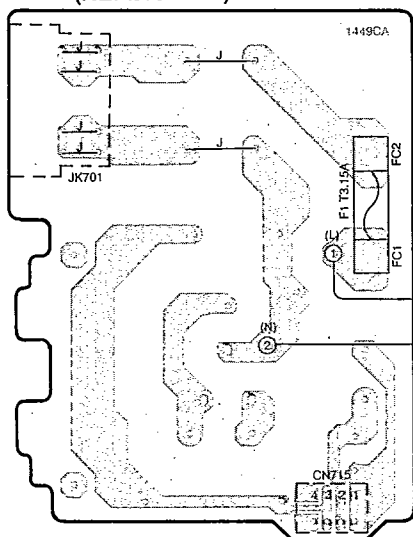

PT701
(Power transformer)

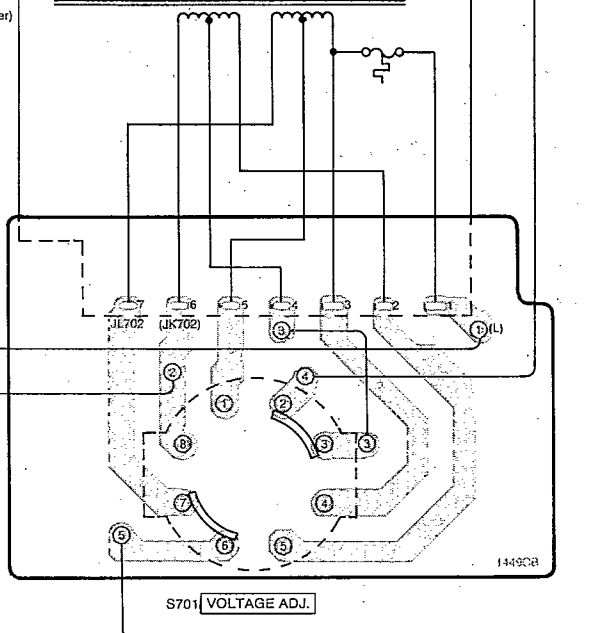

D VOLTAGE SELECTOR P.C.B. (REP2152B-P)

<p>M5218AP</p>	<p>RSN3502</p>	<p>AN6558F</p>	<p>BU2040</p>	<p>2SA1309AIQTA 2SA1309AIRTA 2SC3311AIRTA 2SD1450RTA UN4115 UN4211</p>
<p>2SB1548PQAU 2SD2374PQAU</p>	<p>2SB621A-R</p>	<p>2SC3940ARSTA</p>	<p>2SC1740SQ 2SD2144S DTA114ESTP</p>	<p>MA4100LTA MA4150M MA4240H</p>
<p>1N5402BF RL1N4003N02</p>	<p>MA4051MTA MA4075MTA</p>	<p>1SS254TA MA165 MA700TA</p>	<p>MTZJ5R6BTA MTZJ6R2BTA</p>	<p>SLR-305VC</p>
<p>LNJ301MPUJAD</p>				

■ Wiring Connection Diagram

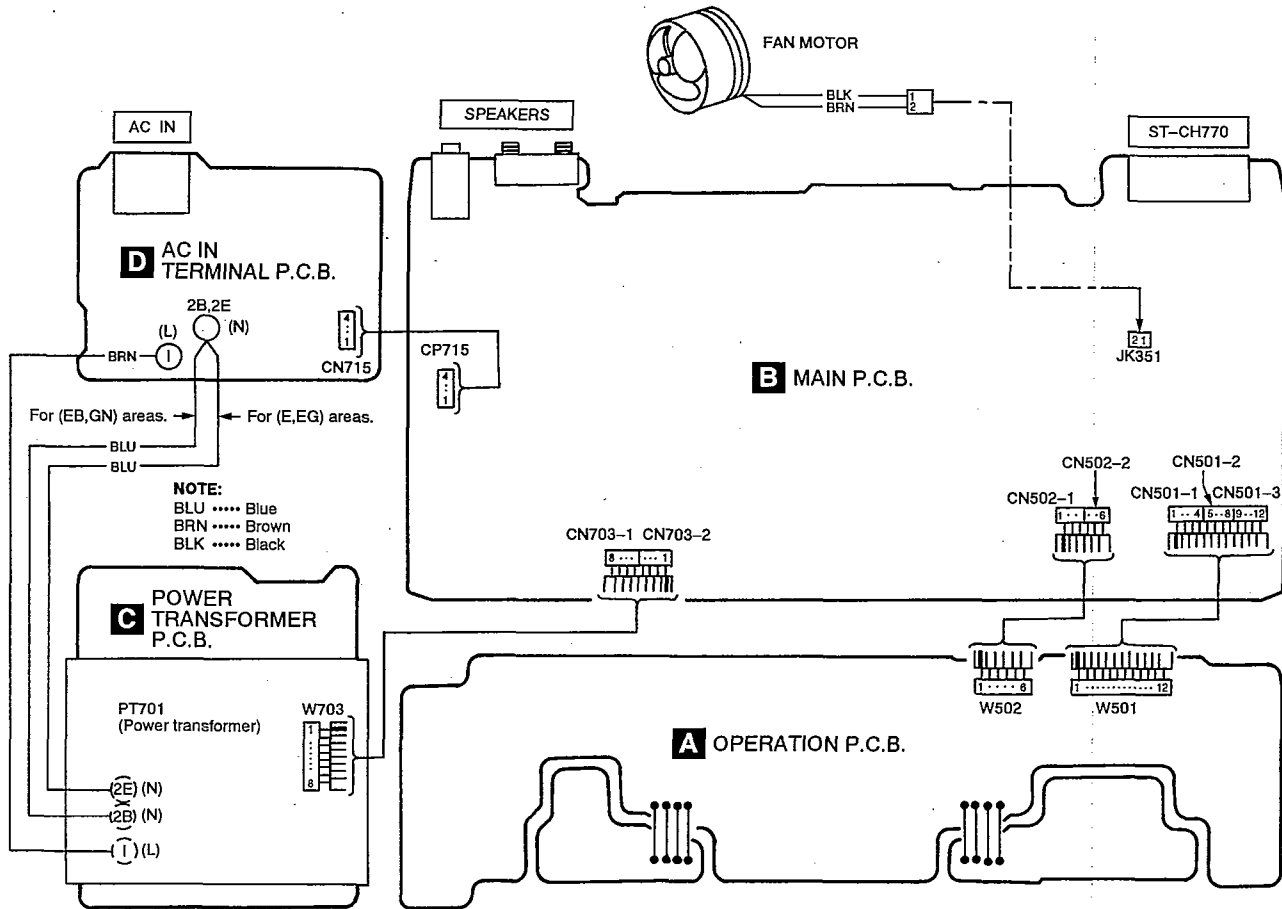

Block Diagram

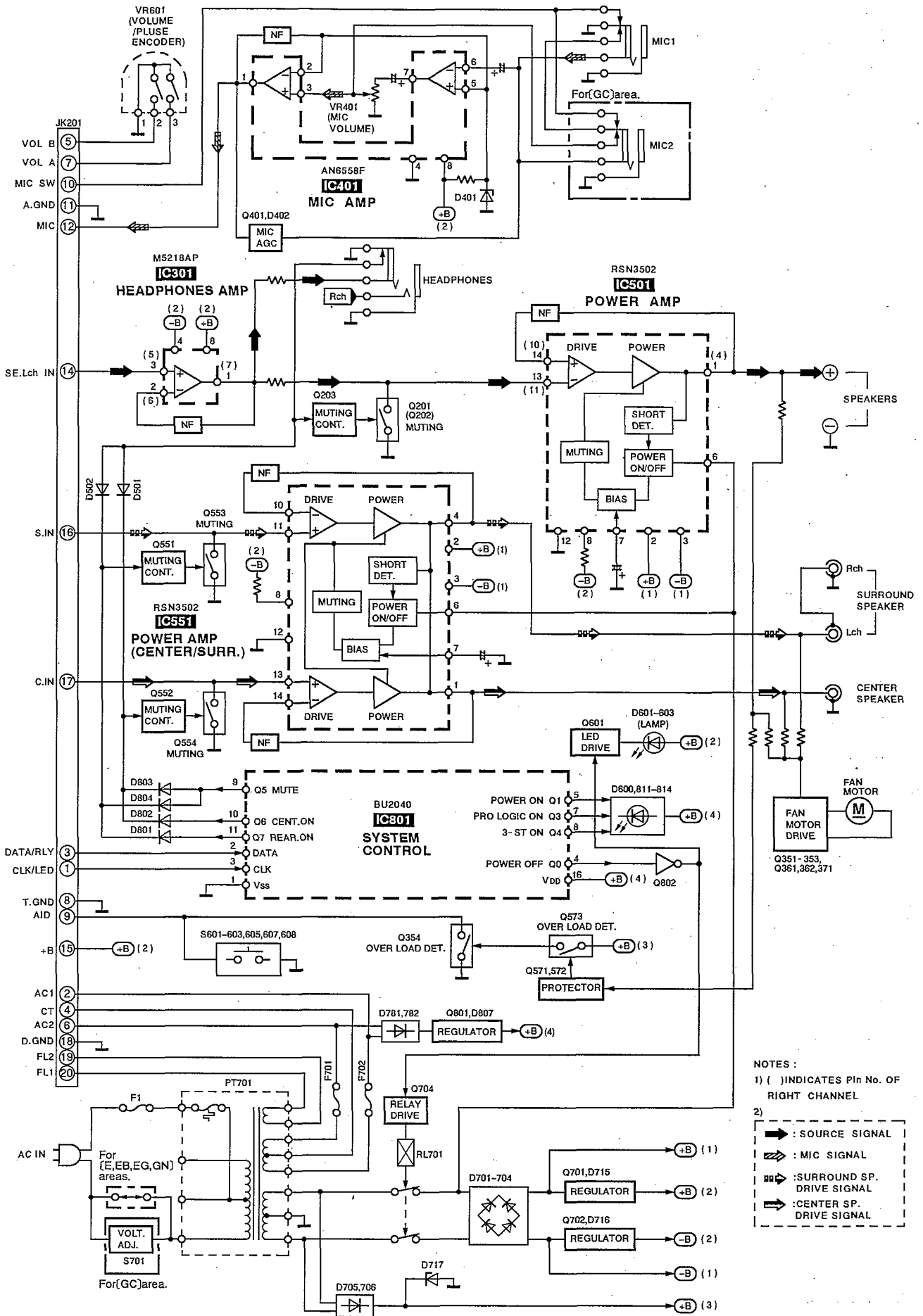

- NOTES :
- 1) () INDICATES Pin No. OF RIGHT CHANNEL
 - 2)
 - ➔ : SOURCE SIGNAL
 - ➔ : MIC SIGNAL
 - ➔ : SURROUND SP. DRIVE SIGNAL
 - ➔ : CENTER SP. DRIVE SIGNAL

Replacement Parts List

Notes: *Important safety notice:

 Components identified by Δ mark have special characteristics important for safety.

Furthermore, special parts which have purposes of fire-retardant (resistors), high-quality sound (capacitors), low-noise (resistors), etc. are used.

When replacing any of components, be sure to use only manufacture's specified parts shown in the parts list.

*The parenthesized indications in the Remarks columns specify the areas. (Refer to the cover page for area.)

Parts without these indications can be used for all areas.

*Remote Control Ass'y: Supply period for three years from termination of production.

*The "(SF)" mark denotes the standard part.

*<VRD>: indicates parts that are supplied by Video Recorder Division.

Ref. No.	Part No.	Part Name & Description	Remarks	Ref. No.	Part No.	Part Name & Description	Remarks
		INTEGRATED CIRCUIT(S)		D705, 706	RL1N4003N02	DIODE	Δ
				D712	MA4240H	DIODE	
				D715, 716	MA4150M	DIODE	Δ
IC301	M5218AP	IC, BUFFER AMP.		D717	MA4051MTA	DIODE	Δ
IC401	AN6558F	IC, MIC AMP.		D781, 782	RL1N4003N02	DIODE	Δ
IC501	RSN3502	IC, POWER AMP.	Δ	D801-804	1SS254TA	DIODE	
IC551	RSN3502	IC, POWER AMP.	Δ	D807	MTZJ5R6BTA	DIODE	Δ
IC801	BU2040	IC, SYSTEM CONTROL		D811-814	LNJ301MPUJAD	L. E. D	
		TRANSISTOR(S)				VARIABLE RESISTOR(S)	
Q201, 202	2SD1450RTA	TRANSISTOR		VR401	RRV11A01B14A	V. R, MIC VOLUME CONTROL	
Q203	UN4115	TRANSISTOR		VR601	EVQ21405R	V. R, MAIN VOLUME CONTROL	
Q351	2SA1309AIRTA	TRANSISTOR				COIL(S)	
Q352	2SB621A-R	TRANSISTOR	Δ	L501, 502	RLQYR73M	COIL	
Q353	2SA1309AIRTA	TRANSISTOR		L551, 552	RLQYR73M	COIL	
Q354	2SC3311AIRTA	TRANSISTOR		L701	RLQ2271M	COIL	Δ (E, EB, EG, GN)
Q361	2SD2144S	TRANSISTOR				FUSE(S)	
Q362	2SA1309AIRTA	TRANSISTOR		F1	XBA2C16TB0	FUSE, 250V T1. 6A	Δ (E, EB, EG, GN)
Q371	2SA1309AIRTA	TRANSISTOR		F1	XBA2C31TB0	FUSE, 250V T3. 15A	Δ (GC)
Q401	2SC1740SQ	TRANSISTOR		F2	XBA2C16TB0	FUSE, 250V T1. 6A	Δ (GC)
Q551, 552	UN4115	TRANSISTOR		F701, 702	XBA2C16TB0	FUSE, 250V T1. 6A	Δ
Q553, 554	2SD1450RTA	TRANSISTOR				SWITCH(ES)	
Q571, 572	2SC3311AIRTA	TRANSISTOR		S601	EVQ21405R	SW, POWER	
Q573	2SA1309AIRTA	TRANSISTOR		S602	EVQ21405R	SW, PRO LOGIC	
Q601	UN4211	TRANSISTOR		S603	EVQ21405R	SW, TEST	
Q701	2SD2374PQAU	TRANSISTOR	Δ	S605	EVQ21405R	SW, CENTER MODE	
Q702	2SB1548PQAU	TRANSISTOR	Δ	S607	EVQ21405R	SW, EQ SPACE/FLAT	
Q704	2SC3311AIRTA	TRANSISTOR		S608	EVQ21405R	SW, V. BASS	
Q801	2SC3940ARSTA	TRANSISTOR	Δ	S701	ESE37314	SW, VOLTAGE SELECTOR	Δ (GC)
Q802	DTA114ESTP	TRANSISTOR				CONNECTOR(S)	
		DIODE(S)		CN501-1	RJS1A6604	CONNECTOR(4P)	
D351	MA165	DIODE		CN501-2	RJS1A6604	CONNECTOR(4P)	
D352	MA4100LTA	DIODE	Δ	CN501-3	RJS1A6604	CONNECTOR(4P)	
D361	MA4075MTA	DIODE	Δ	CN502-1	RJS1A6603	CONNECTOR(3P)	
D362	MA165	DIODE		CN502-2	RJS1A6603	CONNECTOR(3P)	
D371	MA700TA	DIODE		CN701-708	RJS1A1101T1	CONNECTOR(1P)	
D372	MA165	DIODE		CN703-1	RJS1A6604	CONNECTOR(4P)	
D401	MTZJ6R2BTA	DIODE	Δ				
D402	1SS254TA	DIODE					
D501, 502	MA165	DIODE					
D600	SLR-305VC	L. E. D.					
D601-603	LNJ301MPUJAD	L. E. D.					
D701-704	1N5402BF	DIODE	Δ				

Notes : * Capacity values are in microfarads (μF) unless specified otherwise, P=Pico-farads (pF) F=Farads (F)
 * Resistance values are in ohms, unless specified otherwise, 1K=1,000 (OHM) , 1M=1,000k (OHM)

Ref. No.	Part No.	Values & Remarks	Ref. No.	Part No.	Values & Remarks	Ref. No.	Part No.	Values & Remarks
		RESISTORS	R415	ERDS2TJ103	1/4W 10K	R731	ERDS2TJ104	1/4W 100K
			R420	ERDS2TJ104	1/4W 100K	R780	ERDS2TJ822	1/4W 8.2K
			R421	ERDS2TJ223	1/4W 22K (GC)	R783	ERDS2TJ221	1/4W 220
R223, 224	ERDS2TJ103	1/4W 10K	R501, 502	ERDS2TJ102	1/4W 1K	R791, 792	ERDS2TJ101	1/4W 100
R251	ERDS2TJ222	1/4W 2.2K	R503-506	ERDS2TJ563	1/4W 56K	R793	ERQ16NKWR15E	1/6W 0.15
R253, 254	ERDS2EJ121	1/4W 120	R507, 508	ERDS2TJ152	1/4W 1.5K	R801	ERDS2TJ821	1/4W 820
R255	ERDS2TJ154	1/4W 150K	R509, 510	ERDS2TJ821	1/4W 820	R802	ERDS2TJ102	1/4W 1K
R256	ERDS2TJ105T	1/4W 1M	R511	ERDS2TJ334	1/4W 330K	R803	ERDS2TJ122	1/4W 1.2K
R259	ERDS2TJ561	1/4W 560	R512	ERDS2TJ154	1/4W 150K	R804	ERDS2TJ152	1/4W 1.5K
R291, 292	ERDS2TJ562	1/4W 5.6K	R513	ERDS2TJ684	1/4W 680K	R805	ERDS2TJ182	1/4W 1.8K
R301, 302	ERDS2TJ222	1/4W 2.2K	R514 Δ	ERD25FJ470	1/4W 47	R806	ERDS2TJ222	1/4W 2.2K
R303, 304	ERDS2TJ333	1/4W 33K	R515, 516 Δ	ERDS1FVJ100T	1/2W 10	R807	ERDS2TJ332	1/4W 3.3K
R305, 306	ERDS2TJ153	1/4W 15K	R517, 518 Δ	ERD25FVJ100T	1/4W 10	R811, 812	ERDS2TJ332	1/4W 3.3K
R307, 308	ERDS2TJ102	1/4W 1K	R519, 520	ERDS2TJ222	1/4W 2.2K	R813	ERDS2TJ152	1/4W 1.5K
R309-312	ERDS2EJ121	1/4W 120	R551, 552	ERDS2TJ222	1/4W 2.2K	R815, 816	ERDS2TJ102	1/4W 1K
R331, 332	ERDS2TJ122	1/4W 1.2K	R553, 554	ERDS2TJ102	1/4W 1K	R817	ERDS2TJ221	1/4W 220
R351	ERDS2TJ183T	1/4W 18K	R555, 556	ERDS2TJ104	1/4W 100K	R818	ERDS2TJ104	1/4W 100K
R352	ERDS2TJ473	1/4W 47K	R557, 558	ERDS2TJ563	1/4W 56K	R819, 820	ERDS2TJ102	1/4W 1K
R353	ERDS2TJ223	1/4W 22K	R559, 560	ERDS2TJ102	1/4W 1K	R821, 822	ERDS2TJ221	1/4W 220
R354	ERDS2TJ104	1/4W 100K	R561	ERDS2TJ151	1/4W 150	R823	ERDS2TJ392T	1/4W 3.9K
R355	ERDS2TJ103	1/4W 10K	R562	ERDS2TJ471	1/4W 470	R825, 826	ERDS2TJ393	1/4W 39K
R357	ERG1SJ100E	1W 10	R563, 564	ERDS2TJ563	1/4W 56K	R831, 832	ERDS2TJ221	1/4W 220
R358	ERG1SJ220E	1W 22	R565, 566 Δ	ERD25FVJ100T	1/4W 10			
R359	ERDS2TJ273	1/4W 27K	R567, 568 Δ	ERDS1FVJ100T	1/2W 10			CAPACITORS
R360	ERDS2TJ152	1/4W 1.5K	R569	ERDS2TJ823T	1/4W 82K	C251	ECEA0JKA221B	6.3V 220U
R361	ERDS2TJ104	1/4W 100K	R570	ERDS2TJ124T	1/4W 120K	C301, 302	ECEA1HKA222B	50V 0.22U
R362	ERDS2TJ101	1/4W 100	R571	ERDS2TJ823T	1/4W 82K	C303-306	ECBT1H101KB5	50V 100P
R363, 364	ERDS2TJ103	1/4W 10K	R572	ERDS2TJ124T	1/4W 120K	C307, 308	ECEA1CKA220B	16V 22U
R365	ERDS2TJ335T	1/4W 3.3K	R573	ERDS2TJ563	1/4W 56K	C353	ECEA1HKA2R2B	50V 2.2U
R371	ERDS2TJ683	1/4W 68K	R574	ERDS2TJ564	1/4W 560K	C361	ECEA1AKA221B	10V 220U
R372	ERDS2TJ561	1/4W 560	R575	ERDS2TJ223	1/4W 22K	C362, 363	RCE1CKA100BG	16V 10U
R373	ERDS2TJ101	1/4W 100	R583, 584	ERDS2TJ154	1/4W 150K	C364	ECBT1E103ZF	25V 0.01U
R374	ERDS2TJ472	1/4W 4.7K	R585, 586	ERDS2TJ105T	1/4W 1M	C371	ECEA0JKA101B	6.3V 100U
R375	ERDS2TJ103	1/4W 10K	R587, 588	ERDS2EJ121	1/4W 120	C372	ECBT1E103ZF	25V 0.01U
R391	ERDS2TJ473	1/4W 47K	R589	ERDS2TJ561	1/4W 560	C381, 382	ECBT1E103ZF	25V 0.01U
R401	ERDS2TJ332	1/4W 3.3K	R590	ERDS2TJ334	1/4W 330K	C395, 396	ECBT1E223ZF	25V 0.022U
R402	ERDS2TJ332	1/4W 3.3K (GC)	R591 Δ	ERD2FCVG470T	1/4W 47	C397, 398	ECBT1E103ZF	25V 0.01U
R403	ERDS2TJ223	1/4W 22K	R602	ERDS2TJ681	1/4W 680	C401	ECBT1H221KB5	50V 220P
R404	ERDS2TJ122	1/4W 1.2K	R605	ERDS2TJ331	1/4W 330	C403	ECEA1HKA010B	50V 1U
R405	ERDS2TJ184T	1/4W 180K	R701 Δ	ERD2FCVJ47T	1/4W 4.7	C404	ECBT1H221KB5	50V 220P
R406	ERDS2TJ102	1/4W 1K	R702 Δ	ERQ16NKWR2RE	1W 2.2	C405	ECBT1H151KB5	50V 150P
R407	ERDS2TJ104	1/4W 100K	R703, 704	ERDS2TJ562	1/4W 5.6K	C406, 407	ECEA1HKA3R3B	50V 3.3U
R408	ERDS2TJ473	1/4W 47K	R705	ERDS2TJ333	1/4W 33K	C408	ECBT1H181KB5	50V 180P
R409	ERDS2TJ332	1/4W 3.3K	R706	ERDS2TJ100	1/4W 10	C409	ECEA1HKA222B	50V 0.22U (E, EB, EG)
R410	ERDS2TJ102	1/4W 1K	R709	ERG1SJ331E	1W 330	C409	ECEA1HKA2R2B	50V 0.22U (GN)
R411	ERDS2TJ562	1/4W 5.6K	R711	ERG1SJ391E	1W 390	C409	ECEA1HKA47B	50V 0.47U (GC)
R412	ERDS2TJ102	1/4W 1K	R713	ERDS1FVJ1R0T	1/2W 1.0	C410	ECBT1E223ZF	25V 0.022U
R413	ERDS2TJ562	1/4W 5.6K	R716	ERDS2TJ392T	1/4W 3.9K	C411	ECBT1E103ZF	25V 0.01U
R414	ERDS2TJ332	1/4W 3.3K	R717	ERDS2TJ473	1/4W 47K			

Note: The reference number SA represent the grease and tool used for this unit.

Ref. No.	Part No.	Part Name & Description	Remarks	Ref. No.	Part No.	Part Name & Description	Remarks
		CABINET PARTS				PACKING MATERIALS	
1	RKM0202A-K	TOP CABINET		P1	RPG2975	PACKING CASE (SYSTEM)	(E, EB, EG)
2	RHD30007-K1	SCREW		P1	RPG2977	PACKING CASE (SYSTEM)	(GC)
3	XTBS3+10JFZ1	SCREW		P1	RPG2978	PACKING CASE (SYSTEM)	(GN)
4	RFKJECA7-N	BOTTOM CHASSIS ASS'Y	(E, EB, EG, GN)	P2	RPG2777	PACKING CASE (CD)	
4	RFKJECH730GC	BOTTOM CHASSIS ASS'Y	(GC)	P3	RPG2708	PACKING CASE (TUNER)	
4-1	RKA0011-3	FOOT		P4	RPG2707	PACKING CASE (DECK)	
5	RFKHECH770EK	REAR PANEL ASS'Y	(E, EG)	P5	RPG2706	PACKING CASE (AMPLIFIER)	
5	RFKHECH770EB	REAR PANEL ASS'Y	(EB, GN)	P6	RPN0951	PAD (CD)	
5	RFKHECH770GC	REAR PANEL ASS'Y	(GC)	P7	RPN0893	PAD (TUNER)	
6	RKQ0089	SPACER		P8	RPN0892-1	PAD (DECK)	
7	RMCO158	HOLDER		P9	RPN0891	PAD (AMPLIFIER)	
8	RFKGECH770EK	FRONT PANEL ASS'Y	(E, EB, EG, GN)	P10	SPP740	PROTECTION COVER	
8	RFKGECH770GC	FRONT PANEL ASS'Y	(GC)	P11	RPF0139	PROTECTION COVER	
9	RGL0343-Q	PANEL LIGHT		P12	RPQ0541	SPACER	
10	RGL0282-Q	PANEL LIGHT		P13	RPQ0664	SPACER	
11	RGU1433-K	BUTTON, DOLBY/TEST				ACCESSORIES	
12	RGU1224-K	BUTTON, POWER					
13	RGU1431-K	BUTTON, EQ/V. BASS		A1	RAK-CH202WH	REMOTE CONTROL TRANSMITTER	
14	RGU1434-K	BUTTON, CENTER MODE		A1-1	RKK0057-K	BATTERY COVER	
15	RGW0235-K	KNOB, MIC VOLUME		A2	REE0393	SPEAKER CORD (2000mm)	
16	RGW0253-K	KNOB, MAIN VOLUME		A3	REX0608	FLAT CABLE (SHORT)	
17	RHD26016	SCREW		A4	REX0660	FLAT CABLE (MEDIUM)	
18	RKW0465-Q	PANEL		A5	REX0661	FLAT CABLE (LONG)	
19	RMN0329	HOLDER		A6	RJA0019-2K	AC MAINS LEAD	△ (E, EG, GC) (SF)
20	RMV0121	PLATE		A6	RJAD049-K	AC MAINS LEAD	△ (EB)
21	SNE4021-1	MUT		A6	RJAD036-K	AC MAINS LEAD	△ (GN)
22	XTBS26+10J	SCREW		A7	RFKSECH770EK	INSTRUCTION MANUAL ASS'Y	(E)
23	XTBS3+8JFZ1	SCREW		A7	RFKSECH770EB	INSTRUCTION MANUAL ASS'Y	(EB)
24	XTB3+10JFZ	SCREW		A7	RQT3578-D	INSTRUCTION MANUAL	(EG)
25	RMN0191	HOLDER		A7	RQT3580-G	INSTRUCTION MANUAL	(GC)
26	RWJ1808130XX	FLAT CABLE (8P) (W703)	(E, EB, EG, GN)	A7	RQT3579-B	INSTRUCTION MANUAL	(GN)
26	RWJ1808100XX	FLAT CABLE (8P) (J703)	(GC)	A8	RQA0117	WARRANTY CARD	(E, EB, EG)
27	RWJ7012220QC	FLAT CABLE (12P) (W501)		A8	RQX7433ZA	WARRANTY CARD	(GN)
28	RWJ7006200QC	FLAT CABLE (6P) (W502)		A9	RQCBO169	SERVICE CENTER LIST	
29	REM0057	FAN		A10	RSAD012	AM LOOP ANTENNA	
30	XTB3+12JFZ	SCREW		A10-1	RMN0244	ANTENNA HOLDER	
31	XTB3+20JFZ	SCREW		A10-2	XTN3+12AFZ	SCREW	
32	XTB3+8JFZ	SCREW		A11	RSAD007	FM INDOOR ANTENNA	(E, EB, EG)
33	XTW3+15T	SCREW		A11	RSAD006	FM INDOOR ANTENNA	(GC, GN)
34	RMN0190-1	HOLDER	(GC)	A12	SJP5213-2	POWER PLUG ADAPTOR	(GC)
				A13	SJP9009	ATTACHMENT PLUG	(EB)
				A14	RQCA0490	INFORMATION	
						GREASE OR JIG/TOOL	
				SA1	RFKX0002	COMPOUND GREASE	

Cabinet Parts Location

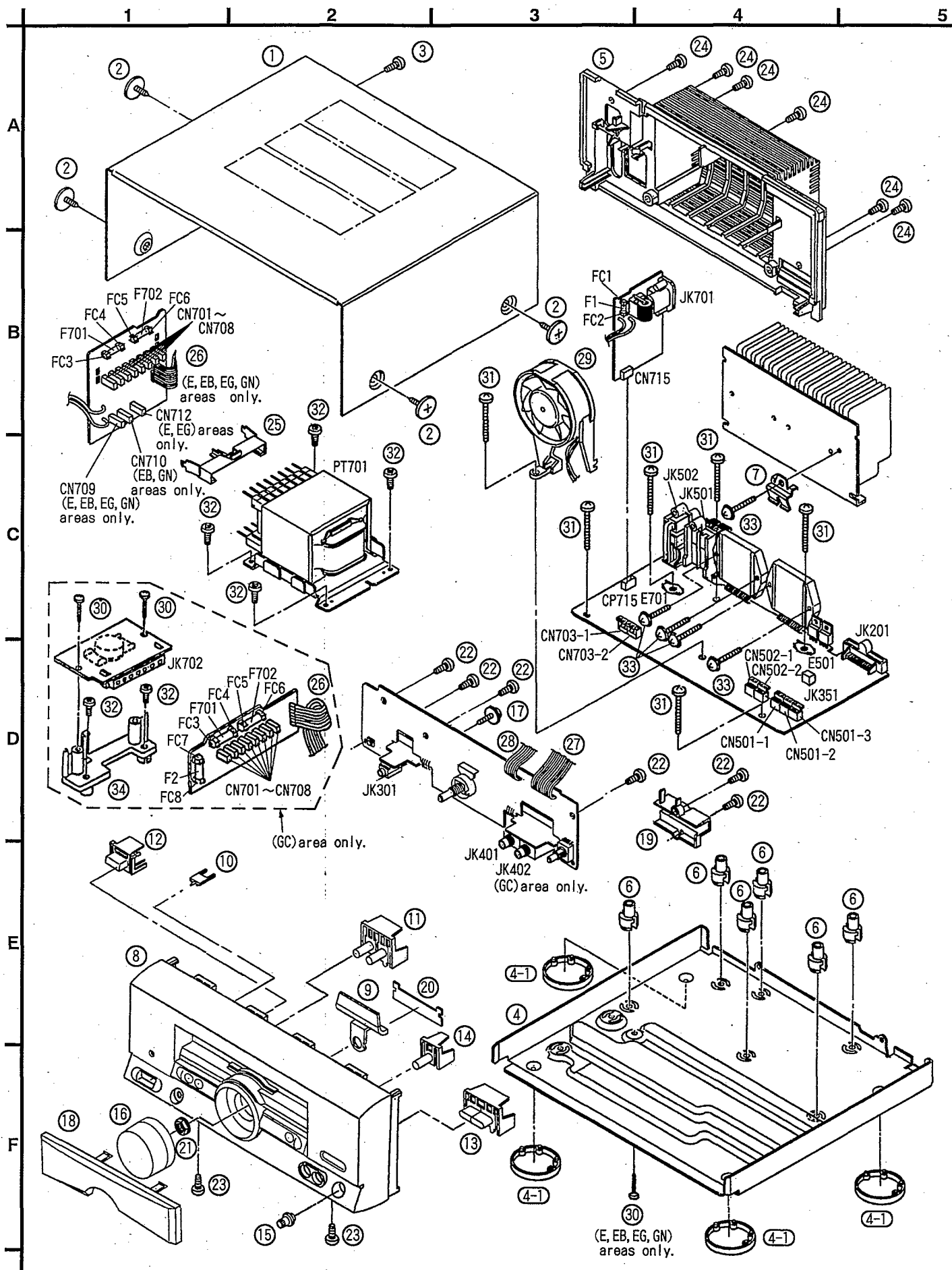

■ Packaging

1023

